

IAPPS, BC

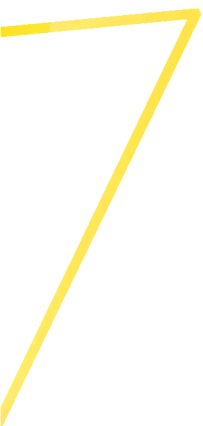

TO

BOWLS



07

**TORNEIRAS, CUBAS,
ACESSÓRIOS GASTRONORM**
*TAPS, BOWLS, GASTRONORM
ACCESSORIES*

TORNEIRAS



236 TORNEIRAS
TAPS

250 LAVA OLHOS DE EMERGÊNCIA
EMERGENCY EYEWASHERS

252 CUBAS E LAVA LOUÇAS
BOWLS AND SINKS

263 ACESSÓRIOS GASTRONORM
GASTRONORM ACCESSORIES

270 DISPENSADORES
DISPENSERS

272 OUTROS ACESSÓRIOS
OTHER ACCESSORIES

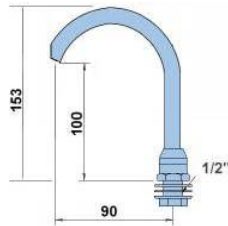

GR.119

Cana "pescoço de cisne" giratória Ø18mm em latão cromado

Chrome plated brass gooseneck swiveling spout, Ø18mm

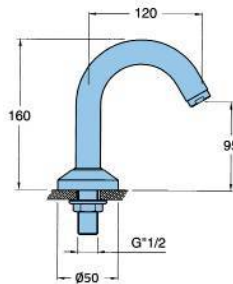

GR.120

Cana "pescoço de cisne" Ø26mm em latão cromado

Chrome plated brass gooseneck spout, Ø26mm

236

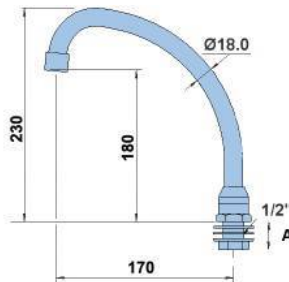

GR.121

Cana "pescoço de cisne" giratória Ø18mm em latão cromado

Chrome plated brass gooseneck swiveling spout, Ø18mm

A (MM)

GR.121 F 25

GR.121 G 60

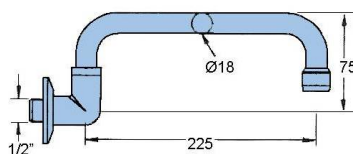

GR.124

Cana giratória de parede em latão cromado Ø18x225mm, altura 75mm

Chrome plated brass wall mounted swiveling spout, Ø18x225mm, height 75mm

GR.125

Cana de parede Ø18x150mm em latão cromado

Chrome plated brass Wall mounted spout, Ø18x150mm

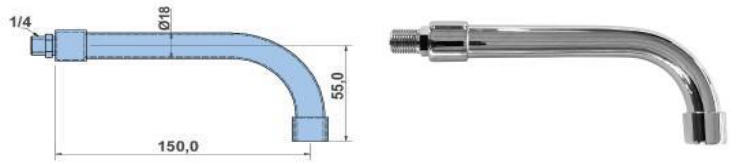

GR.133 E

Torneira misturadora em latão cromado, bi-pedal de 2 águas

Chrome plated brass double foot operated mixer valve

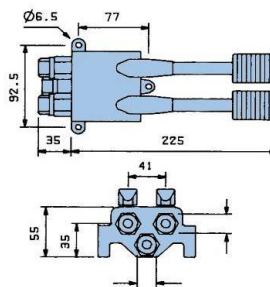

GR.134

Torneira misturadora em latão cromado, bi-pedal de 2 águas

Chrome plated brass double foot operated mixer valve

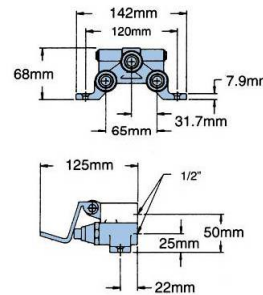

GR.135

Torneira de Joelho de 1 água em latão cromado

Chrome plated single knee operated valve, single water inlet

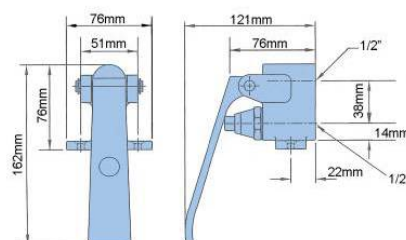

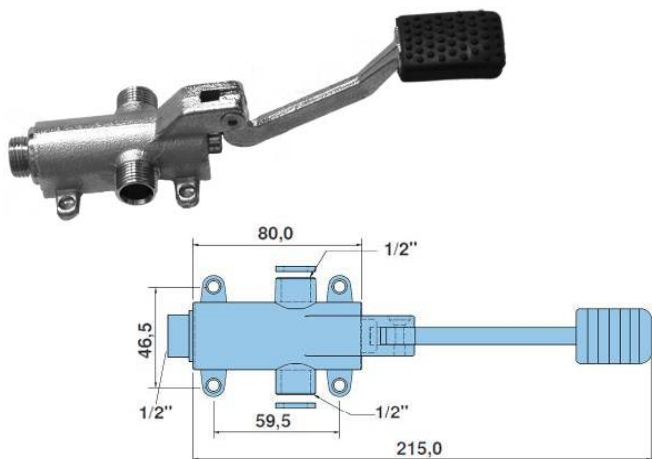

GR.139.3

Torneira misturadora em latão cromado, mono-pedal de 2 águas

Nota: Ao instalar a torneira é obrigatório colocar os filtros na entrada de água

Opção: AC.1250 / AC.1250-1 (Pg. 242)

Chrome plated brass single foot operated mixer valve

Note: When installing the valve, it is mandatory to put the filters in the water inlet

Option: AC.1250 / AC.1250-1 (Pg. 242)

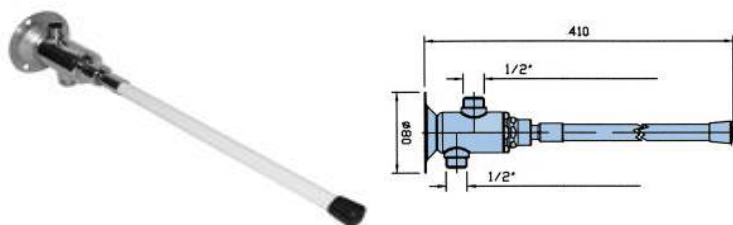

GR.136

Torneira de joelho, de 1 água e temporizada

Single knee operated valve, single water inlet and with timer

238

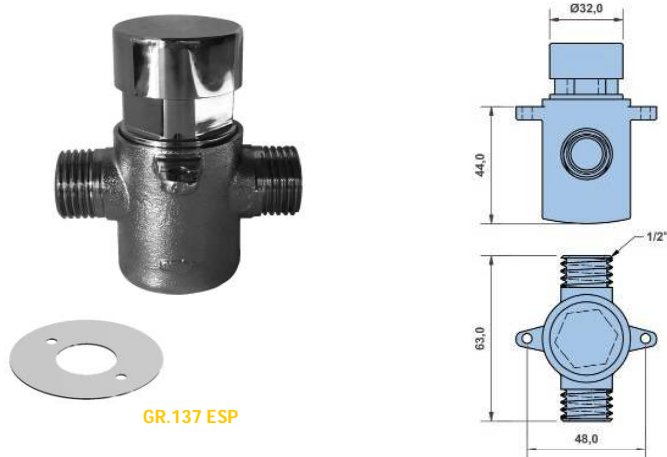

GR.137 ESP

GR.137

Torneira em latão cromado, mono-comando de 1 água

Nota: Ao instalar a torneira é obrigatório colocar o filtro na entrada de água

Opção: GR.137 ESP - Espelho em aço inox

Chrome plated brass single operated valve - single water inlet

Note: When installing the valve, it is mandatory to put the filter in the water inlet

Option: GR.137 ESP - Stainless steel base plate

GR.137.1 - Com temporizador / *With timer*

GR.137.1 ST - Sem temporizador / *Without timer*

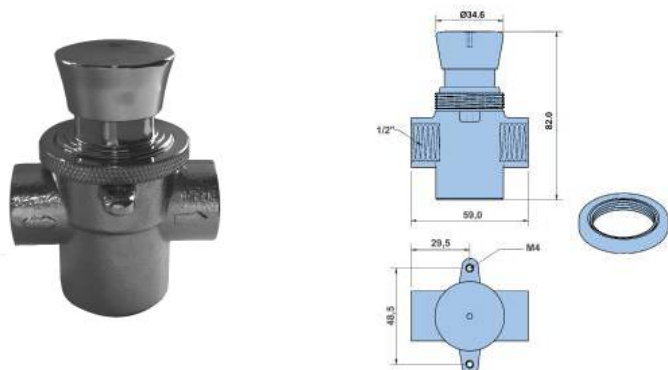

GR.145

Torneira de pulsação de uma água
Temporização regulável (3 a 20 seg)

Fixação inferior com parafusos ou superior com porca

One water inlet push button tap

Time flow regulation (3 to 20 sec)

Inferior fixation with screws or superior with nut

GR.150

Torneira de lavatório em latão cromado de uma água com sensor de infravermelhos. 220-240V

Chrome plated faucet with infra-red sensor, single water inlet. 220-240V

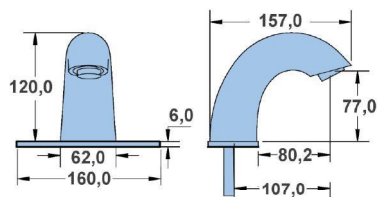

COMPONENT
HARDWARE

GR.150 T

Torneira de lavatório em latão cromado de uma água com sensor de infravermelhos

Chrome plated faucet with infra-red sensor, single water inlet

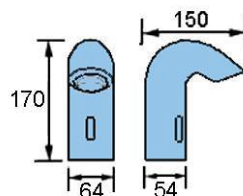

GR.110

Chuveiro para limpeza de forno com suporte

Oven cleaning shower with support

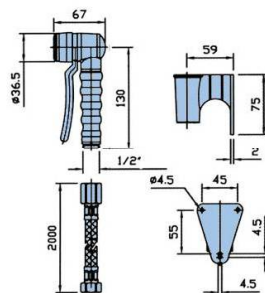

GR.210

Torneira de coluna com cana orientável

Column tap with swiveling spout

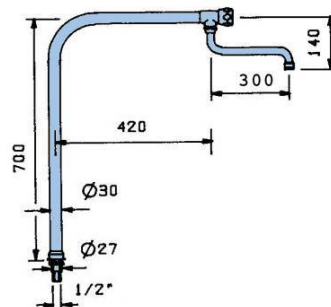

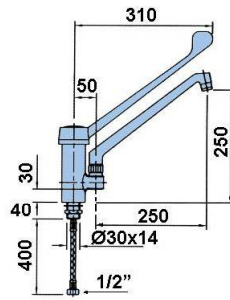

GR.220

Torneira misturadora monocomando de 2 águas, mono-furo com alavanca clínica

Single deck mounted gerontological tap, double water inlet

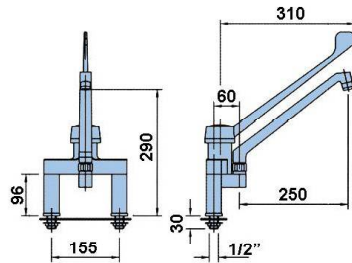

GR.221

Torneira misturadora monocomando de 2 águas, bi-furo com alavanca clínica

Double deck mounted gerontological tap, double water inlet

240

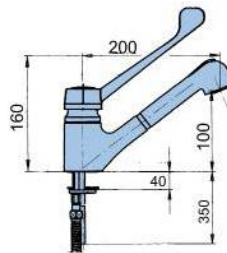

GR.222

Torneira misturadora monocomando de 2 águas, mono-furo com chuveiro extensível

Single deck mounted tap with flexible hose, double water inlet

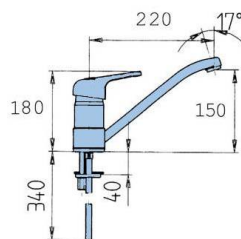

GR.223

Torneira misturadora monocomando de 2 águas, mono-furo

Single deck mounted tap, double water inlet

GR.224

Torneira misturadora monocomando de 2 águas, mono-furo

Single deck mounted tap, double water inlet

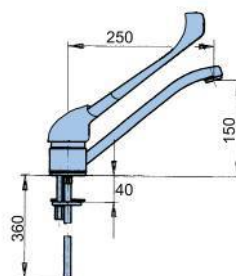

GR.225

Torneira misturadora vertical monocomando de 2 águas

Vertical single deck mounted tap, double water inlet

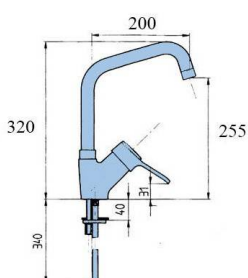

GR.226

Torneira misturadora vertical monocomando de 2 águas

Vertical single deck mounted tap, double water inlet

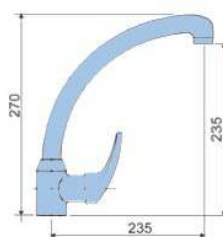

GR.227

Torneira misturadora vertical monocomando de 2 águas

Vertical single deck mounted tap, double water inlet

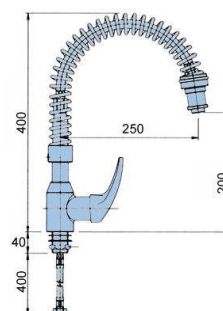

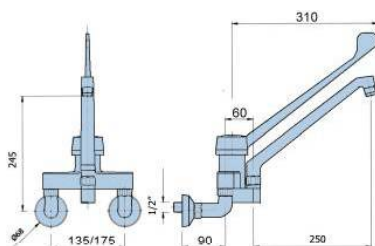

GR.228

Torneira misturadora de parede, monocomando de 2 águas

Double wall mounted tap

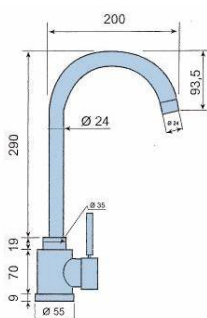

GR.231

Torneira misturadora vertical de 2 águas mono-furo e cana curva

Monoblock deck mounted tap with curved spout

242

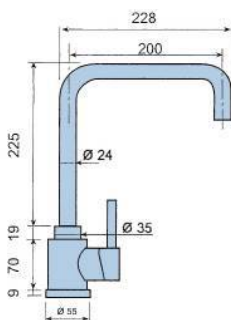

GR.232

Torneira misturadora vertical de 2 águas mono-furo e cana recto

Monoblock deck mounted tap with straight spout

GR.350 E

Bica com cana orientável de 300mm;
Adaptável aos modelos GR.310E, GR.320E, GR.330E
e GR.340E

*Add-on tap with 300mm spout.
Suitable for models GR.310E, GR.320E, GR.330E e GR.340E*

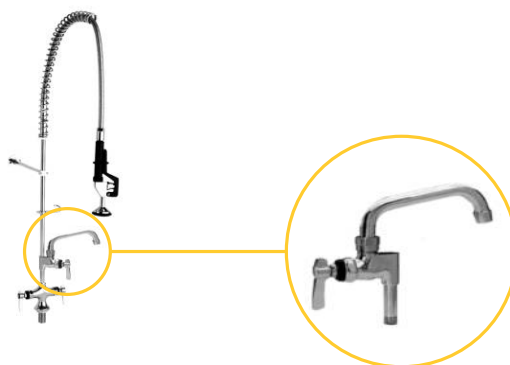

GR.221 D

Duche lava louças de bancada com torneira misturadora
de bancada monocomando 2 águas bi-furo com alavanca
clínica

Altura total: Aprox.1040mm
Altura bancada-chuveiro: 250mm
Distância cana-chuveiro: 380mm
Distância entre furos: 155mm

*Double deck mounted pre-rinse unit with flexible hose and
gerontological tap; double water inlet*

*Total height: Aprox.1040mm
Deck spray clearance: 250mm
Faucet-spray dist: 380mm
Distance between holes: 155mm*



GR.315 E

Duche lava louças de bancada, com torneira misturadora
bi-furo vertical de duas águas, com torneira intermédia

Altura total: Aprox.965mm
Altura bancada-chuveiro: 254mm
Distância cana-chuveiro: 367mm

*Double deck mounted pre-rinse unit with flexible hose, double
water inlet, with intermediate tap*

*Total height: Aprox.965mm
Deck spray clearance: 254mm
Faucet-spray dist: 367mm*





GR.316

Duche lava louças de bancada com torneira misturadora mono-furo e com torneira intermedia

Altura total: Aprox. 610mm
Altura bancada-chuveiro: 130mm
Distância cana-chuveiro: 130mm

Single deck mounted pre-rinse unit with flexible hose, double water inlet with intermediate tap

*Total height: Aprox. 610mm
Deck spray clearance: 130mm
Faucet-spray dist: 130mm*



GR.320 E

Duche lava louças de parede, com torneira misturadora bi-furo vertical de 2 águas

Altura total: Aprox. 890mm
Altura bancada-chuveiro: 178mm
Distância cana-chuveiro: 381mm
Distância entre furos: 205mm

Double wall mounted pre-rinse unit with flexible hose, double water inlet

*Total height: Aprox. 890mm
Deck spray clearance: 178mm
Faucet-spray dist: 381mm
Distance between holes: 205mm*



GR.330 E

Duche lava louças de bancada, com torneira misturadora mono-furo de 1 água

Altura total: Aprox. 965mm
Altura bancada-chuveiro: 254mm
Distância cana-chuveiro: 381mm

Single deck mounted pre-rinse unit with flexible hose, single water inlet

*Total height: Aprox. 965mm
Deck spray clearance: 254mm
Faucet-spray dist: 381mm*

GR.340 E

Duche lava louças de bancada de 1 água sem comando

Altura total: Aprox. 890mm
Altura bancada-chuveiro: 178mm
Distância cana-chuveiro: 381mm

Single deck mounted pre-rinse unit with flexible hose, without valve

Total height: Aprox. 890mm
Deck spray clearance: 178mm
Faucet-spray dist: 381mm



GR.345

Duche lava louça aéreo com equilibrador

Overhead mount pre-rinse unit with balancer



GR.31010

Pistola adaptável para duche lava louças GR.310-340

Pressure water gun for application on GR.310-340



GR.31020

Punho plástico para pistola GR.31010

Plastic sleeve for GR.31010 water gun





GR.31030

Tubo flexível em inox para torneiras de duche
(44"/1118mm)

Stainless steel hose for shower taps (44"/1118mm)



GR.31031

Tubo flexível em inox para torneiras de duche
(72"/1830mm)

Stainless steel hose for shower taps (72"/1830mm)

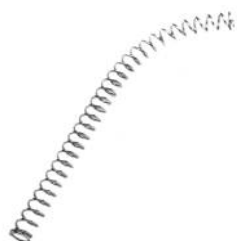

GR.31040

Mola helicoidal em inox para torneiras de duche

Stainless steel coil spring for shower faucets



GR.31061 E

Válvula água fria para torneiras duche

Cold water valve for shower faucets



GR.31062 E

Válvula água quente para torneiras duche

Hot water valve for shower faucets

GR.31063 E

Manipulo para torneiras duche

Handle for shower faucets



GR.100

Pré regulador de temperatura com válvulas anti-retorno

Temperature pre-regulator with no-return valves

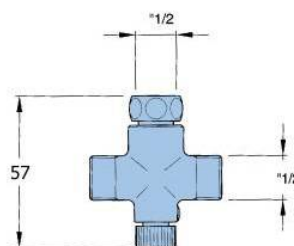

GR.300

Desenrolador com mangueira de 10mts
(não inclui pistola)

*10 meter hose reel
(pressure water gun not included)*



GR.301

Desenrolador em aço inox com mangueira de 15mts
(não inclui pistola)

*Stainless steel 15 meter hose reel
(pressure water gun not included)*



GR.31011

Pistola adaptável para GR.300 ou GR.301

Pressure water gun for application on GR.300 or GR.301





GR.31012

Pistola de pressão com saída para espuma

Pressure water gun with foam outlet



GR.31013

Pistola de alta pressão (sem mangueira)

High pressure water gun (hose not included)



GR.31014

Pistola de pressão (sem mangueira)

Pressure water gun (hose not included)



AC.1250

Kit para torneira GR.139.3; (1-bujão 1/2, 1-anilha 1/2, 4-buchas M8 e 4-Parafusos 5x50 PZD)

Kit for tap GR.139.3; (1-1/2 plug ; 1-1/2Washer ; 4-M8 Bushings and 4-5X50 PZD screws)



AC.1250-1

Kit com válvula de retenção para GR.139.3

Kit with non-return valve for GR.139.3

AC.1347

Bicha flexível 1000mm Macho/fêmea 1/2

1000mm flexible hose male/female 1/2

AC.1348

Bicha flexível 1000mm Macho/fêmea 1/2

1000mm flexible hose male/female 1/2

AC.1347-1

Bicha flexível 500mm Macho/fêmea 1/2

500mm flexible hose male/female 1/2

AC.1348-1

Bicha flexível 500mm Macho/fêmea 1/2

500mm flexible hose male/female 1/2



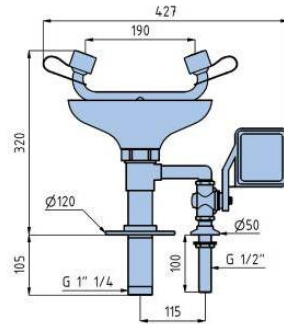

GR.2112

Lava olhos de emergência
Fixação à bancada e bandeja em ABS

*Emergency eyewash
Deck mounting and ABS bowl*

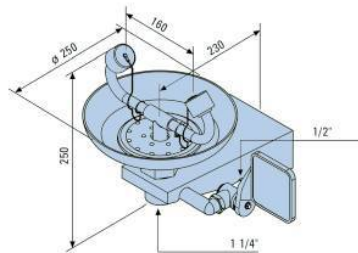

GR.2210

Lava olhos de emergência
Fixação à parede e bandeja em ABS

*Emergency eyewash
Wall mounting and ABS bowl*

250

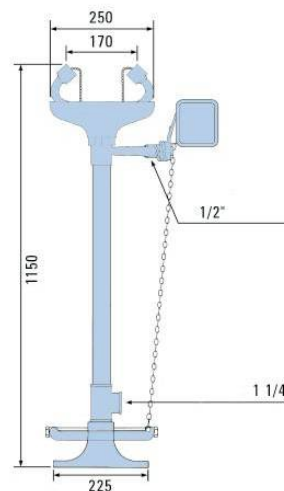

GR.2113

Lava olhos de emergência
Fixação ao solo e bandeja em ABS

*Emergency eyewash
Floor mounting and ABS bowl*

GR.2114

Duche e lava olhos de emergência
 Fixação ao solo, com acionador triplo e bandeja em ABS

*Emergency shower/eyewash
 With foot treadle, floor mounting and ABS shower head/bowl*

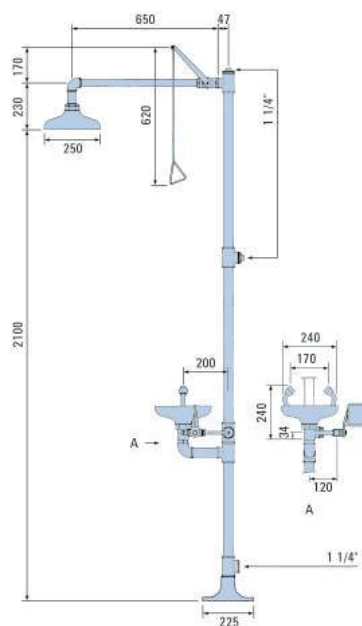

GR.2115

Cabine de descontaminação automática com 14 aspersores

Self-draining decontamination booth platform with 14 sprays

✓ Outros modelos sob consulta
Other models under request

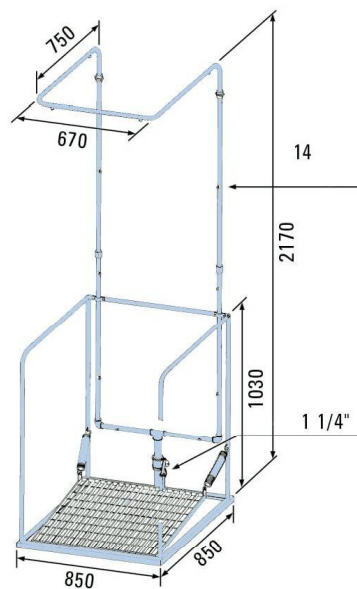



CS3230159 - CS12511349D/I

Cubas para soldar em inox AISI 304 de 1mm de espessura
Com furo de Ø90

*AISI 304 stainless steel bowls 1mm thick for welding
With Ø90 hole*

	DIMENSÕES (mm) DIMENSIONS (mm)	RAIO RADIUS
CS3230159 C	325X300X150	45
CS3333209	330X330X200	50
CS4034169D/I	400X340X160	50
CS4034209D/I	400X340X200	50
CS4040209	400X400X200	63
CS4040259	400X400X250	63
CS4040309	400X400X300	63
CS4545259	450X450X250	80
CS4545309	450X450X300	80
CS5040259D/I *	500X400X250	80
CS5040309D/I *	500X400X300	80
CS5050259	500X500X250	80
CS5050309	500X500X300	80
CS6050309D/I *	600X500X300	90
CS0951349D/I *	955X510X340	45
CS12511349D/I *	1280X510X340	45



BM11215 - BM41340

Cubas para banho maria gastronorm em inox AISI 304
de 1mm de espessura

*AISI 304 stainless steel bain-Marie gastronorm basins
1mm thick*

	GN	DIMENSÕES (mm) DIMENSIONS (mm)	RAIO RADIUS
BM11215	1/1	510X310X215	40
BM21215	2/1	630X510X215	45
BM21170	2/1	630X510X170	45
BM31170	3/1	960X510X170	45
BM31215	3/1	960X510X215	45
BM31340	3/1	960X510X340	45
BM4117	4/1	1280X510X170	45
BM41215	4/1	1280X510X215	45
BM41340	4/1	1280X510X340	45

PR.830 - PR.90

Cubas redondas em inox AISI 304 **para soldar** com diversos diâmetros

Válvula com sistema anti-inundação incluída

AISI 304 stainless steel round bowls in different diameters for welding

Valve with anti-flood system included

	H (MM)	Ø (MM)
PR.830	180	300
PR.836	180	360
PR.85	180	380
PR.90	180	420

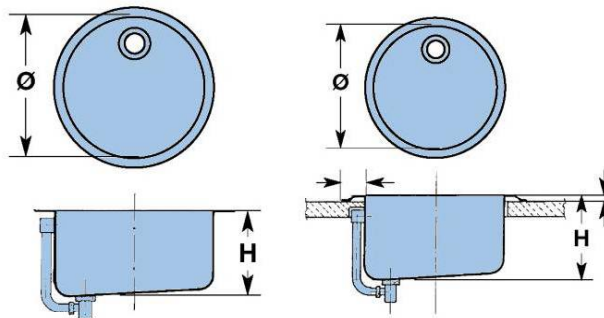

PR.830 - PR.90

PR.830 C/B - PR.90 C/B

PR.830C/B - PR.90C/B

Cubas redondas em inox **para encastrar** com diversos diâmetros

Válvula com sistema anti-inundação incluída

Stainless steel round bowls in different diameters for mounting

Valve with anti-flood system included

	H (MM)	Ø (MM)
PR.830C/B	160	300
PR.836C/B	160	360
PR.85C/B	160	380
PR.90C/B	160	420



F0765-0

Lava louças industriais em inox AISI 304, alçado de 100mm com raio sanitário

Inclui tubo de escoamento

AISI-304 stainless steel industrial sinks 100mm backplate with sanitary radius

Overflow pipe included

	DIMENSÕES (MM) DIMENSIONS (MM)	CUBA BOWL
F0765-0	700X600	500X500X300

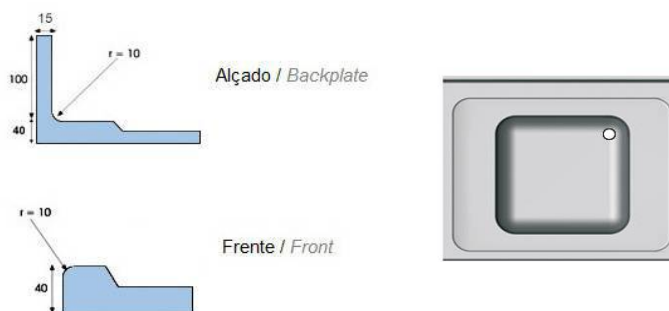

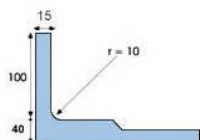

Alçado / Backplate

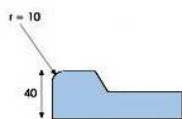

Frente / Front

✓ * D/I (Direito/Esquerdo) indica posição do escoador
* D/I (Right/Left) indicates the drainer position

F1064-D/I - F1465-D/I

Lava louças industriais em inox AISI 304, alçado de 100mm com raio sanitário

Inclui tubo de escoamento

*AISI-304 stainless steel industrial sinks 100mm backplate with sanitary radius
Overflow pipe included*

	DIMENSÕES (MM) <i>DIMENSIONS (MM)</i>	CUBA <i>BOWL</i>
F1064-D/I *	1000X600	500X400X300
F1264-D/I *	1200X600	500X400X300
F1465-D/I *	1400X600	500X500X300

254

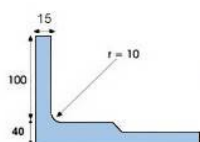

Alçado / Backplate

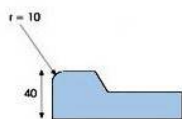

Frente / Front

✓ * D/I (Direito/Esquerdo) indica posição do escoador
* D/I (Right/Left) indicates the drainer position

F1062-2 - F1465-2

Lava louças industriais em inox AISI 304, alçado de 100mm com raio sanitário

Inclui tubo de escoamento

*AISI-304 stainless steel industrial sinks 100mm backplate with sanitary radius
Overflow pipe included*

	DIMENSÕES (MM) <i>DIMENSIONS (MM)</i>	CUBA <i>BOWL</i>
F1062-2	1000X600	400X400X250
F1264-2	1200X600	500X400X300
F1465-2	1400X600	500X500X300

F1464-D/I - F1865-D/I

Lava louças industriais em inox AISI 304, alçado de 100mm com raio sanitário

Inclui tubo de escoamento

*AISI-304 stainless steel industrial sinks 100mm backplate with sanitary radius
Overflow pipe included*

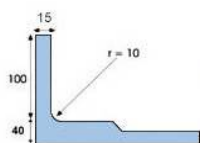

Alçado / Backplate

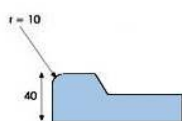

Frente / Front

✓ * D/I (Direito/Esquerdo) indica posição do escoador
* D/I (Right/Left) indicates the drainer position

	DIMENSÕES (MM) <i>DIMENSIONS (MM)</i>	CUBA <i>BOWL</i>
F1464-D/I *	1400X600	500X400X300
F1664-D/I *	1600X600	500X400X300
F1865-D/I *	1800X600	500X500X300

F2165-2

Lava louças industriais em inox AISI 304, alçado de 100mm com raio sanitário

Inclui tubo de escoamento

AISI-304 stainless steel industrial sinks 100mm backplate with sanitary radius
Overflow pipe included

	DIMENSÕES (MM) DIMENSIONS (MM)	CUBA BOWL
F2165-2	2100X600	500X500X300

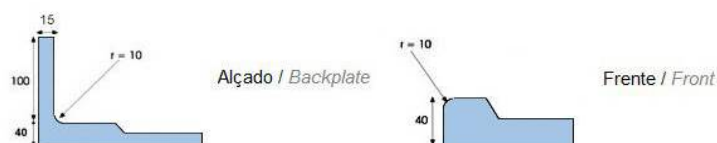

F0776-0 - F0876-0

Lava louças industriais em inox AISI 304, alçado de 100mm com raio sanitário

Inclui tubo de escoamento

AISI-304 stainless steel industrial sinks 100mm backplate with sanitary radius
Overflow pipe included

	DIMENSÕES (MM) DIMENSIONS (MM)	CUBA BOWL
F0776-0	700X700	600X500X320
F0876-0	800X700	600X500X320

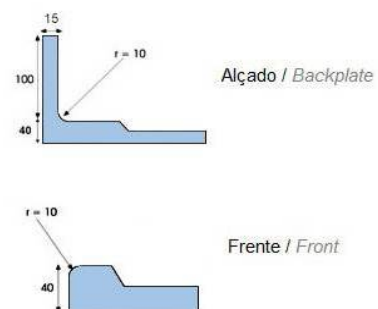

F1074-D/I - F1476-D/I

Lava louças industriais em inox AISI 304, alçado de 100mm com raio sanitário

Inclui tubo de escoamento

AISI-304 stainless steel industrial sinks 100mm backplate with sanitary radius
Overflow pipe included

	DIMENSÕES (MM) DIMENSIONS (MM)	CUBA BOWL
F1074-D/I *	1000X700	500X400X300
F1275-D/I *	1200X700	500X500X300
F1476-D/I *	1400X700	600X500X320

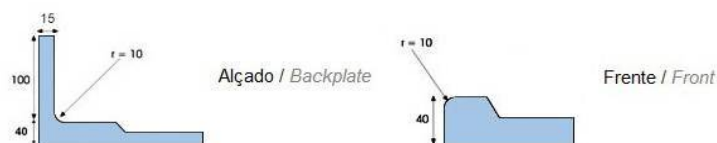

☑ * D/I (Direito/Esquerdo) indica posição do escorredor
 * D/I (Right/Left) indicates the drainer position

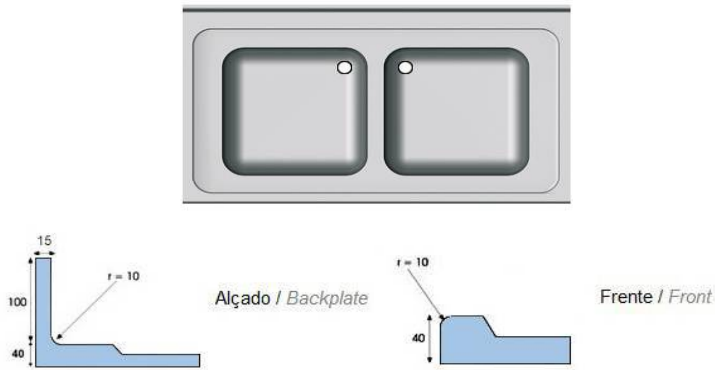

F1275-2 - F1476-2

Lava louças industriais em inox AISI 304, alçado de 100mm com raio sanitário

Inclui tubo de escoamento

*AISI-304 stainless steel industrial sinks 100mm backplate with sanitary radius
Overflow pipe included*

	DIMENSÕES (MM) <i>DIMENSIONS (MM)</i>	CUBA <i>BOWL</i>
F1275-2	1200X700	500X500X300
F1476-2	1400X700	600X500X320

256

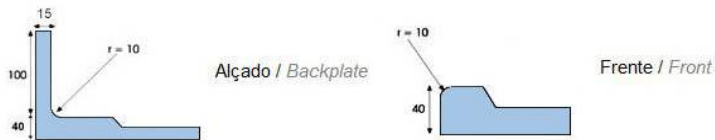

✓ * D/I (Direito/Esquerdo) indica posição do escoador
* D/I (Right/Left) indicates the drainer position

F1675-D/I - F2176-D/I

Lava louças industriais em inox AISI 304, alçado de 100mm com raio sanitário

Inclui tubo de escoamento

*AISI-304 stainless steel industrial sinks 100mm backplate with sanitary radius
Overflow pipe included*

	DIMENSÕES (MM) <i>DIMENSIONS (MM)</i>	CUBA <i>BOWL</i>
F1675-D/I *	1600X700	500X500X300
F1875-D/I *	1800X700	500X500X300
F2176-D/I *	2100X700	600X500X320

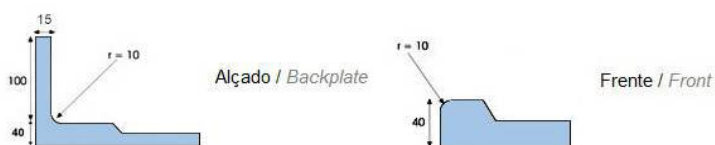

F2175-2 - F2476-2

Lava louças industriais em inox AISI 304, alçado de 100mm com raio sanitário

Inclui tubo de escoamento

*AISI-304 stainless steel industrial sinks 100mm backplate with sanitary radius
Overflow pipe included*

	DIMENSÕES (MM) <i>DIMENSIONS (MM)</i>	CUBA <i>BOWL</i>
F2175-2	2100X700	500X500X300
F2476-2	2400X700	600X500X320

F1279-0 - F1471-0

Lava louças industriais em inox AISI 304, alçado de 100mm com raio sanitário

Inclui tubo de escoamento

AISI-304 stainless steel industrial sinks 100mm backplate with sanitary radius

Overflow pipe included

	DIMENSÕES (MM) <i>DIMENSIONS (MM)</i>	CUBA <i>BOWL</i>
F1279-0	1200X700	955X510X380
F1471-0	1400X700	1280X510X380



F1679-D/I - F2071-D/I

Lava louças industriais em inox AISI 304, alçado de 100mm com raio sanitário

Inclui tubo de escoamento

AISI-304 stainless steel industrial sinks 100mm backplate with sanitary radius

Overflow pipe included

	DIMENSÕES (MM) <i>DIMENSIONS (MM)</i>	CUBA <i>BOWL</i>
F1679-D/I *	1600X700	955X510X380
F2071-D/I *	2000X700	1280X510X380

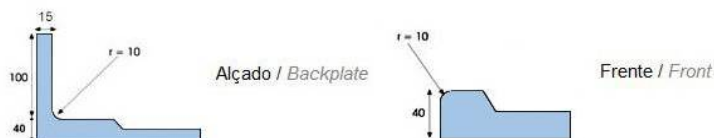

✓ * D/I (Direito/Esquerdo) indica posição do escorredor
* D/I (Right/Left) indicates the drainer position

F2077-D/I

Lava louças industriais em inox AISI 304, alçado de 100mm com raio sanitário

Inclui tubo de escoamento

AISI-304 stainless steel industrial sinks 100mm backplate with sanitary radius

Overflow pipe included

	DIMENSÕES (MM) <i>DIMENSIONS (MM)</i>	CUBA <i>BOWL</i>
F2077-D/I *	2000X700	633X510X380

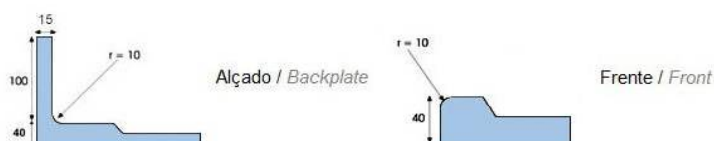

✓ * D/I (Direito/Esquerdo) indica posição do escorredor
* D/I (Right/Left) indicates the drainer position

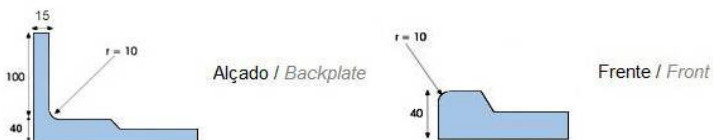

F2179-0

Lava louças industriais em inox AISI 304, alçado de 100mm com raio sanitário
Inclui tubo de escoamento

*AISI-304 stainless steel industrial sinks 100mm backplate with sanitary radius
Overflow pipe included*

	DIMENSÕES (MM) DIMENSIONS (MM)	CUBA BOWL
F2179-0	2100X700	955X510X380



F0851-D/I - F0951-D/I

Lava louças semi-industriais em inox AISI 304, alçado de 30mm

AISI-304 stainless steel semi-industrial sinks 30mm backplate

	DIMENSÕES (MM) DIMENSIONS (MM)	CUBA BOWL
F0851-D/I *	800X500	340X360X150
F0951-D/I *	900X500	340X360X150

258

✓ * D/I (Direito/Esquerdo) indica posição do escorredor
* D/I (Right/Left) indicates the drainer position



F1051-D/I

Lava louças semi-industriais em inox AISI 304, alçado de 30mm

AISI-304 stainless steel semi-industrial sinks 30mm backplate

	DIMENSÕES (MM) DIMENSIONS (MM)	CUBA BOWL
F1051-D/I *	1000X500	340X360X150

✓ * D/I (Direito/Esquerdo) indica posição do escorredor
* D/I (Right/Left) indicates the drainer position



F0852-2

Lava louças semi-industriais em inox AISI 304, alçado de 100mm com raio sanitário

AISI-304 stainless steel semi-industrial sinks 100mm backplate with sanitary radius

	DIMENSÕES (MM) DIMENSIONS (MM)	CUBA BOWL
F0852-2	800X500	340X365X150

F1252-D/I - F1352-D/I

Lava louças semi-industriais em inox AISI 304, alçado de 30mm

AISI-304 stainless steel semi-industrial sinks 30mm backplate

	DIMENSÕES (MM) <i>DIMENSIONS (MM)</i>	CUBA <i>BOWL</i>
F1252-D/I *	1200X500	340X365X150
F1352-D/I *	1350X500	340X365X150



✓ * D/I (Direito/Esquerdo) indica posição do escorredor
* D/I (Right/Left) indicates the drainer position

FS.085-1 - F085-1/15

Lava louças para soldar em inox AISI 304

Welding sinks AISI 304 stainless steel

FS.085-1 - Bordo de 42,5mm / 42,5mm border

FS.085-1/15 - Bordo de 15mm / 15mm border

	DIMENSÕES (MM) <i>DIMENSIONS (MM)</i>	CUBA <i>BOWL</i>
FS.085-1	840X540	370X340X150
FS.085-1/15	785X485	370X340X150



LV124

Lavatório coletivo em inox AISI 304

AISI 304 stainless steel hand-washer bowl

	DIMENSÕES (MM) <i>DIMENSIONS (MM)</i>	CUBA <i>BOWL</i>
LV124	1200X435	1140X320X160



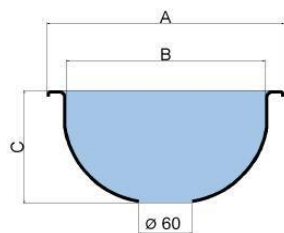

LV20-36

Lavatório semi-esférico de encastrar em inox AISI 304, com acabamento brilhante

AISI 304 stainless steel semi-spherical hand-washer bowl for top mounting with polished finish

	A (MM)	B (MM)	C (MM)
LV20	230	200	105
LV26	295	260	115
LV30	330	300	140
LV36	388	360	150

260

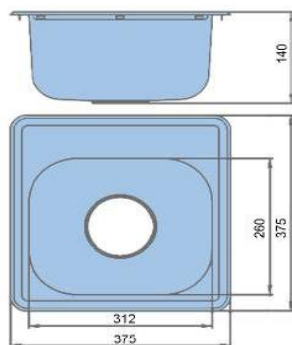

LV38-2

Lavatório de encastrar em inox AISI 304
Inclui válvula Ø60

*AISI 304 stainless steel hand-washer bowl for top mounting
Includes Ø60 valve*

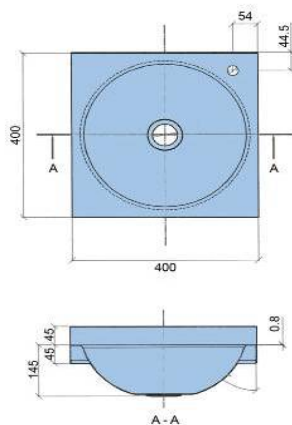

LV44

Lavatório de pousar em inox AISI 304 com cuba semi-esférica e alçado
Inclui válvula Ø60

*AISI 304 stainless steel semi-spherical hand-washer bowl for drop in with backplate
Includes Ø60 valve*

	DIMENSÕES (MM) DIMENSIONS (MM)	CUBA BOWL
LV44	400X400	Ø350X150

LV33

Lavatório de canto para pousar em inox AISI 304 e com alçado

AISI 304 stainless steel hand-washer bowl for drop in with backplate for corner application

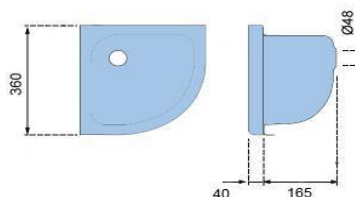

	DIMENSÕES (MM) DIMENSIONS (MM)	CUBA BOWL
LV33	360X360	300X305X165

LV43

Lavatório de pousar em inox AISI 304 com alçado
Inclui válvula Ø60

*AISI 304 stainless steel hand-washer bowl for drop in with backplate
Includes Ø60 valve*

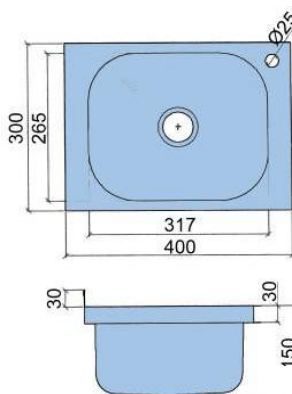

	DIMENSÕES (MM) DIMENSIONS (MM)	CUBA BOWL
LV43	400X300	310X260X150

LV45

Lavatório de pousar em inox AISI 304 com alçado
Inclui válvula Ø60

*AISI 304 stainless steel hand-washer bowl for drop in with backplate
Includes Ø60 valve*

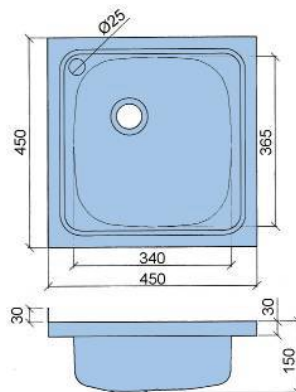

	DIMENSÕES (MM) DIMENSIONS (MM)	CUBA BOWL
LV45	450X450	365X340X150

LV455

Lavatório de pousar em inox AISI 304 com alçado
Inclui válvula Ø60

*AISI 304 stainless steel hand-washer bowl for drop in with backplate
Includes Ø60 valve*

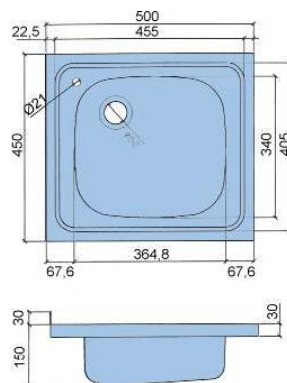

	DIMENSÕES (MM) DIMENSIONS (MM)	CUBA BOWL
LV455	450X500	365X340X150

Com furo ladrão
With overflow

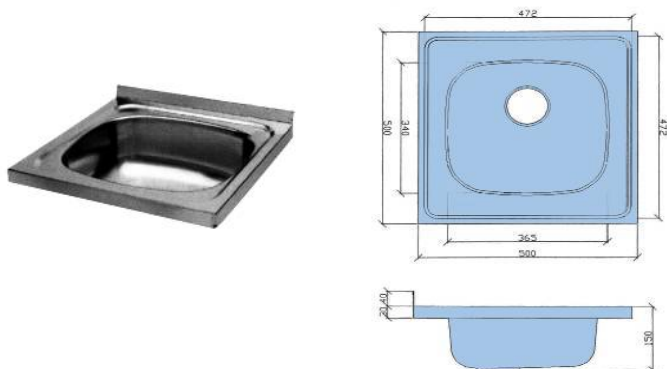

LV55

Lavatório de pousar em inox AISI 304 com alçado
Inclui válvula Ø60

*AISI 304 stainless steel hand-washer bowl for drop
in with backplate
Includes Ø60 valve*

	DIMENSÕES (MM) <i>DIMENSIONS (MM)</i>	CUBA <i>BOWL</i>
LV55	500X500	365X340X150

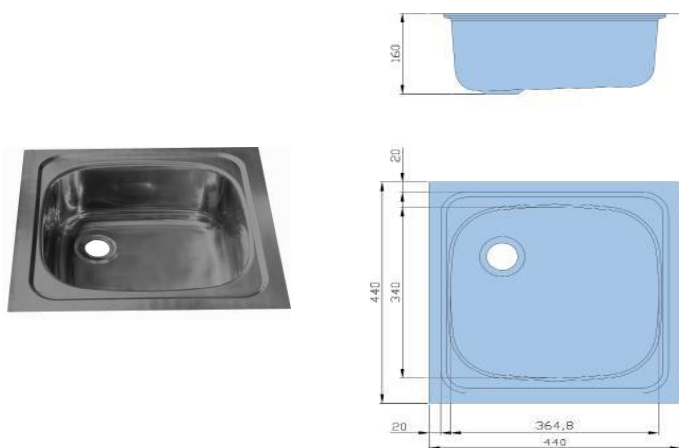

LV444

Lavatório para soldar em inox AISI 304, pio polido,
sem furo anti-inundação
Inclui válvula Ø60

*Polished AISI 304 stainless steel hand-washer bowl
for welding, without anti-flood hole
Includes Ø60 valve*

	DIMENSÕES (MM) <i>DIMENSIONS (MM)</i>	CUBA <i>BOWL</i>
LV444	440X440	365X340X160



CS3613

Lavatório para soldar em inox AISI 304 com Ø350x150mm
Com furo Ø60

*Ø350x150mm AISI 304 stainless steel hand-washer bowl
Ø60 hole*



CS312615

Lavatório para soldar em inox AISI 304 com
310x260x150mm. Com furo Ø60

*310x260x150mm AISI 304 stainless steel hand-washer bowl
Ø60 hole*

CGG181608 A CGG422025

Cubetas para gelados em aço inox

Stainless steel ice-cream containers

	DIMENSÕES (mm) DIMENSION (mm)	H (mm)
CGG181608		80
CGG181612	180X165	120
CGG181615		150
CGG261608		80
CGG261612	265X160	120
CGG261615		150
CGG261617		170
CGG331608		80
CGG331613	330X165	120
CGG331615		150
CGG331617		170
CGG361608		80
CGG361612	360X165	120
CGG361615		150
CGG361617		170
CGG362504		40
CGG362508		80
CGG362512	360X250	120
CGG362515		150
CGG362517		170
CGG212012		120
CGG212015	210X200	150
CGG212017		170
CGG212020		200
CGG422015		150
CGG422017	420X200	170
CGG422020		200
CGG422025		250









CG2102 - CG1910



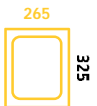

Cubetas GN em aço inox

Stainless steel GN containers



	DIMENSÕES (mm) DIMENSIONS (mm)	GN	ALTURA (mm) HEIGHT (mm)	CAP. (LTS.) CAP. (LTS.)	
CG2102			20	-	
CG2104	650	2/1	40	40	
CG2106			65	65	
CG2110			100	100	
CG2115			150	150	
CG2120			200	200	
CG1102				20	-
CG1104		1/1	40	5.1	
CG1106	530		65	9.2	
CG1110			100	14.2	
CG1115			150	21.3	
CG1120			200	28.4	
CG2302				20	-
CG2304			2/3	40	3.1
CG2306	353	65		5.6	
CG2310		100		9.1	
CG2315		150		13.2	
CG2320		200		18.3	
CG1202				20	-
CG1204			1/2	40	2.0
CG1206	265	65		4.1	
CG1210		100		6.6	
CG1215		150		9.7	
CG1220		200		12.7	
CG2402				20	-
CG2404			2/4	40	-
CG2406	530	65		3.8	
CG2410		100		6.0	
CG2415		150		9.0	



	DIMENSÕES (mm) DIMENSIONS (mm)	GN	ALTURA (mm) HEIGHT (mm)	CAP. (LTS.) CAP. (LTS.)
CG1302			20	-
CG1304			40	1.5
CG1306		1/3	65	2.5
CG1310			100	4.1
CG1315			150	5.8
CG1320			200	7.9
CG1402			20	-
CG1404			40	-
CG1406		1/4	65	1.8
CG1410			100	2.8
CG1415			150	4.1
CG1420			200	5.6
CG2806			65	1.5
CG2810		2/8	100	2.8
CG2815			150	4.3
CG1606			65	1.0
CG1610		1/6	100	1.6
CG1615			150	2.4
CG1620			200	3.5
CG1906		1/9	65	0.6
CG1910			100	1.0

 Também disponível em policarbonato (PC)
Also available in polycarbonate (PC)



CG2102 P - CG1220 P

Cubetas perfuradas em aço inox

Perforated stainless steel containers

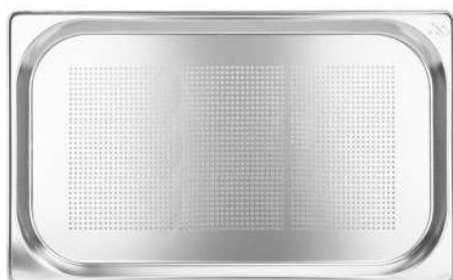





	DIMENSÕES (mm) DIMENSIONS (mm)	GN	ALTURA (mm) HEIGHT (mm)
CG2102P			20
CG2104P	650		40
CG2106P		2/1	65
CG2110P			100
CG2115P			150
CG2120P			200
CG1102P			20
CG1104P	530		40
CG1106P		1/1	65
CG1110P			100
CG1115P			150
CG1120P			200
CG2302P			20
CG2304P	353		40
CG2306P		2/3	65
CG2310P			100
CG2315P			150
CG2320P			200
CG1202P			20
CG1204P	265		40
CG1206P		1/2	65
CG1210P			100
CG1215P			150
CG1220P			200

BG212 - BG126

Bandejas GN em aço inox para fornos, com rebordo plano

Stainless steel GN baking trays, with flat edge

	DIMENSÕES (mm) DIMENSIONS (mm)	GN	ALTURA (mm) HEIGHT (mm)
BG212	 650X530	2/1	20
BG214			40
BG216			65
BG112	 530X325	1/1	20
BG114			40
BG116			65
BG232	 353X325	2/3	20
BG234			40
BG236			65
BG122	 265X325	1/2	20
BG124			40
BG126			65



TG11 - TG24

Tampas para cubetas GN em aço inox

Stainless steel lids for GN containers

	GN	MATERIAL MATERIAL
TG11	1/1	AÇO INOX STAINLESS STEEL
TG23	2/3	
TG12	1/2	
TG24	2/4	
TG13	1/3	
TG14	1/4	
TG16	1/6	
TG19	1/9	



 Também disponível em policarbonato (PC)
 Also available in polycarbonate (PC)

TG11C - TG24C

Tampas recortadas para cubetas GN em aço inox

Stainless steel split lids for GN containers

	GN	MATERIAL MATERIAL
TG11C	1/1	AÇO INOX STAINLESS STEEL
TG23C	2/3	
TG12C	1/2	
TG24C	2/4	
TG13G	1/3	
TG14C	1/4	
TG16C	1/6	



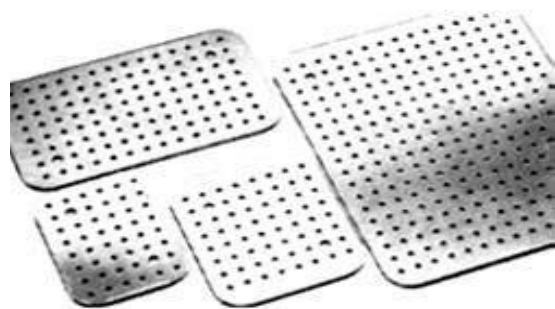

FP11 - FP23

Fundos perfurados GN em aço inox

Stainless steel GN drilled bottom

DIMENSÕES DIMENSION

FP21	GN2/1
FP11	GN 1/1
FP23	GN 2/3
FP12	GN 1/2
FP13	GN 1/3



GR11 - GR64

Grelhas GN em aço inox

Stainless steel GN grids

DIMENSÕES DIMENSION

GR21	GN2/1
GR11	GN 1/1
GR64	600X400MM



GS53

Guia separadora 530mm GN

GN dividing bar 530mm



CGASA

Par de asas retráteis para todos os contentores GN

Pair of retractable handles suitable for all GN containers

PR.2604

Cubeta lava doseadores de gelados em aço inox

Stainless steel batcher washing tray

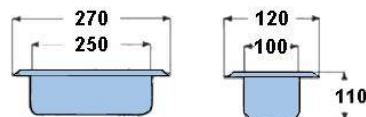

PR.2604/A

Cubeta lava doseadores de gelados em aço inox com acessórios de carga e descarga de água e separador interno

Stainless steel batcher washing tray with accessories for feeding and draining water and internal divider

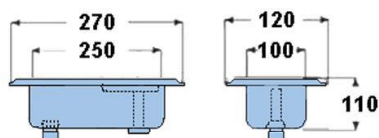

PR.2604/B

Cubeta lava doseadores de gelados em aço inox, com acessórios de carga e descarga de água, separador interno e válvula de esfera e sifão de descarga

Batcher washing tray, with accessories for feeding and draining water and internal divider and also ball valve and drain trap

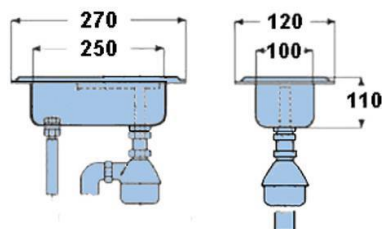

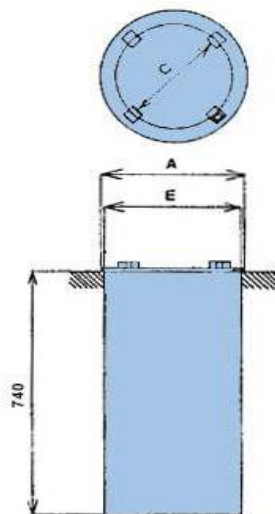

DS.100 - 104

Dispensador de pratos de nível constante, sem aquecimento para pratos desde 160mm a 340mm
Capacidade até 60 pratos

*Unheated plate dispenser available for plates from 160mm to 340mm diameter
Plate capacity of up to 60 units*

	A (MM)	C (MM)	E (MM)	H (MM)
DS.100	300	160-210	286	740
DS.101	330	190-240	316	740
DS.102	370	230-280	356	740
DS.103	400	260-310	386	740
DS.104	430	290-340	416	740

270

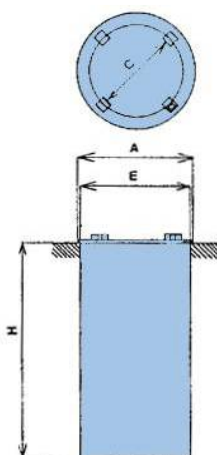

DS.200 - 204

Dispensador de pratos de nível constante, com aquecimento através de resistência de 400W, interruptor iluminado e termostato regulável, para pratos desde 160mm a 340mm
Capacidade até 60 pratos

*400W heated incounter plate dispenser with neon-light switch and selectable thermostat available for plates from 160mm to 340mm diameter
Plate capacity of up to 60 units*

	A (MM)	C (MM)	E (MM)	H (MM)
DS.200	300	160-210	286	760
DS.201	330	190-240	316	760
DS.202	370	230-280	356	760
DS.203	400	260-310	386	760
DS.204	430	290-340	416	760



Tampa para DS.200 a DS.203
Lid for DS.200 to 203



Tampa para DS.204
Lid for DS.204

DS.300 - 303

Dispensador de tabuleiros/cestos de nível constante encastrável
 Modelos disponíveis para tabuleiros/cestos 370x470mm até 670x540mm
 Altura efetiva da pilha de tabuleiros/cestos de 485mm a 590mm

*Unheated incounter tray/basket dispenser
 Available for trays/baskets from 370x470mm to 670x540mm
 Effective stacking height 485 to 590mm*

	AXB (MM)	CXD (MM)	EXF (MM)	H (MM)	S (MM)
DS.300	726X620	670X540	595X675	730	590
DS.301	566X590	510X510	565X515	730	590
DS.302	436X620	380X540	595X385	665	485
DS.303	426X550	370X470	525X375	665	485

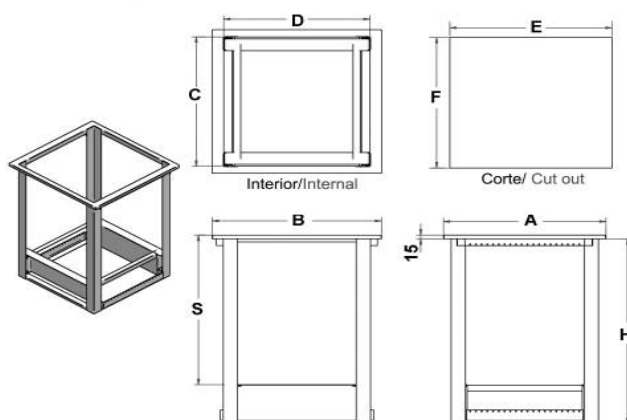

DS.400 - 405

Dispensador de copos em inox (acabamento satinado, espessura 0.6mm e altura de 610mm). Carregamento dos copos pela parte frontal com tensão por molas. Perfil visível com 7mm de altura. Removível com 1/4 de volta. Fornecido com anel para um melhor ajuste

Stainless steel cup dispenser (satin finish, 0.6mm gauge and 610 mm height). Frontal loading with spring tension. Low profile: only 7mm protrusion above countertop. 1/4 turn releases dispenser from countertop. Ring for better adjustment

	Ø COPO Ø CUP	Ø FURO Ø HOLE	Ø GOLA Ø FLAP	APLICAÇÃO APPLICATION
DS.400	56-81	110	135	VERTICAL
DS.401	56-81	110	135	HORIZONTAL
DS.402	63-98	120	150	VERTICAL
DS.403	63-98	120	150	HORIZONTAL
DS.404	100-124	145	170	VERTICAL
DS.405	100-124	145	170	HORIZONTAL





AC.1190

Válvula de esgoto para cubas com furo Ø60mm

Sewage valve for bowls with Ø60mm hole

AC.1191

Válvula de esgoto para cubas com furo Ø90mm

Sewage valve for bowls with Ø90mm hole



AC.1192

Válvula de esgoto com cesta para cubas com furo Ø90mm

Sewage valve for bowls with Ø90mm hole



AC.1196

Sifão plástico para lava-louças de 1 pia, com ligação para sistema anti-inundação

Plastic syphon for 1 bowl sink, connection for anti-flood system



AC.1196-3

Sifão industrial Ø90mm

Nota: Contém filtro removível no interior

Ø90mm industrial syphon

Nota: *Contains removable filter inside*

AC.1186

Válvula de esgoto 1-1/2" com cruz em latão cromado com porca em latão e vedante em borracha

Chrome plated brass 1-1/2" sewage valve with cross, brass nut and rubber seal

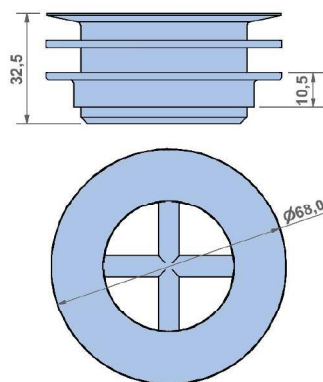

AC.1186-1

Válvula de esgoto 1-1/2" sem cruz em latão cromado com porca em latão e vedante em borracha

Chrome plated brass 1-1/2" sewage valve without cross, brass nut and rubber seal

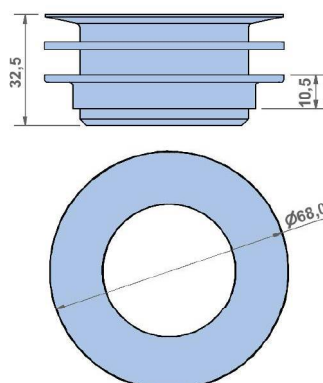

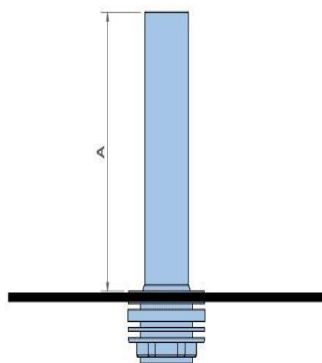

TR.200 - 380

Válvula cromada 1-1/2" e tubo anti-inundação em inox
Chromed valve 1-1/2" and stainless steel overflow pipe

	ALTURA CUBA (MM) BOWL DEPTH (MM)	A* (MM)
TR.200	200	180
TR.250	250	230
TR.300	300	280
TR.320	320	300
TR.380	380	360

✓ * Aproximadamente
* Approximately

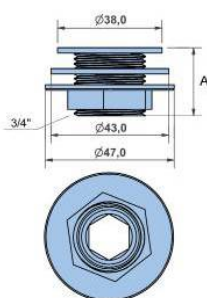

AC.1118 - AC.1118-1

Válvula de esgoto 3/4" em latão cromado com porca em latão e vedante

Opção: AC.1119

Chrome plated brass 3/4" sewage valve, with brass nut and seal

Option: AC.1119

	A (MM)
AC.1118	25
AC.1118-1	50

274

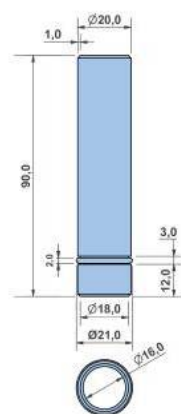

AC.1119

Tubo anti-inundação Ø20X90mm em aço inox
Stainless steel Ø20X90mm overflow pipe

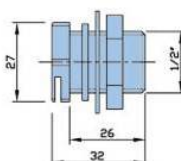

GR.122

Bocal de saída para cuba de banho maria
Drain nozzle for bain-marie bowl

AC.1207

Resistência 400x290mm ultra-fina em silicone para cubas de banho maria

230V-1000W

Temperatura máxima de funcionamento: +150°C

Inclui termostato de segurança (150°C) e adesivo

Ultra-flat 400x290mm silicone resistance for bain-marie bowls

230V-1000W

Maximum working temperature: +150°C

Includes safety thermostat (150°C) and adhesive

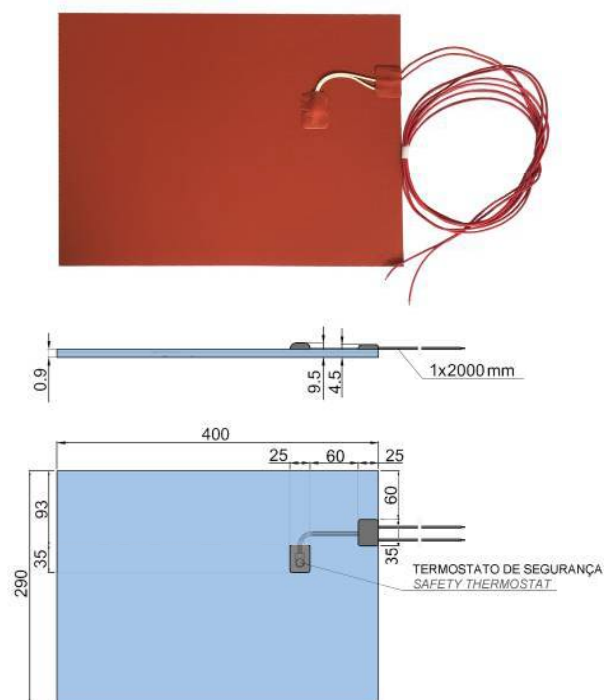

AC.1207-1

Resistência 470x278mm ultra-fina em silicone para cubas de banho maria

230V-550W

Temperatura máxima de funcionamento: +105°C

Inclui termostato de segurança (140°C) e adesivo

Ultra-flat 470x278mm silicone resistance for bain-marie bowls

230V-550W

Maximum working temperature: +105°C

Includes safety thermostat (140°C) and adhesive

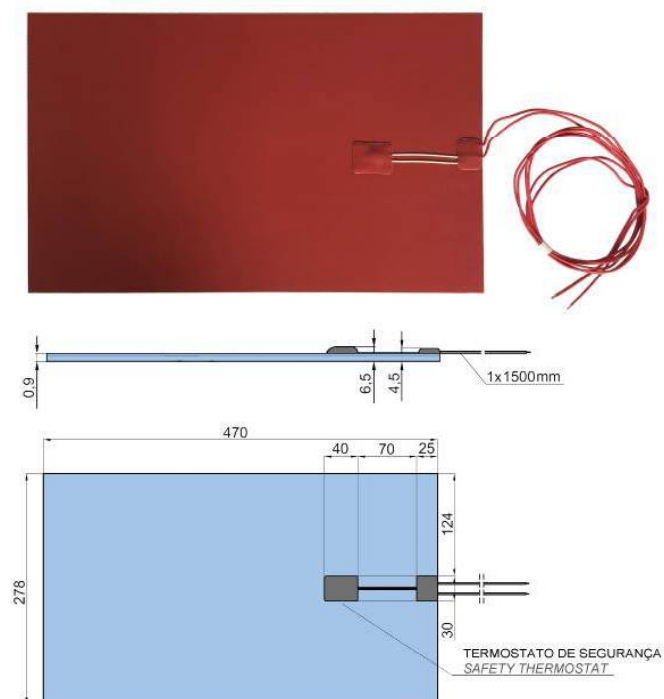

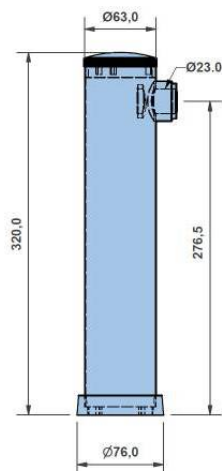

AC.1218

Coluna para tiragem de cerveja

Beer column

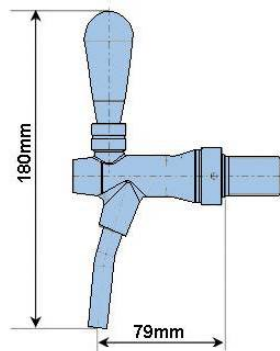

GR.022

Torneira para colunas de cerveja

Beer column tap

276

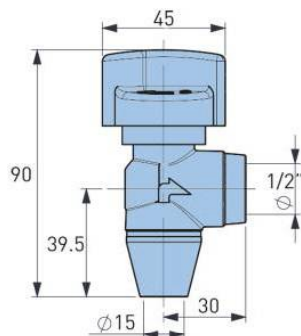

GR.140

Torneira de 1/2 com segurança para fritadeiras

1/2 safety tap for fryers

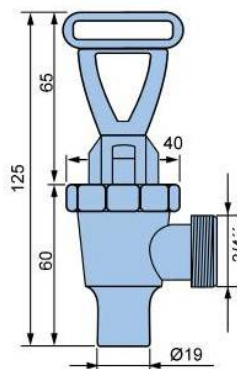

GR.106

Torneira de drenagem para recipientes.
(Botão na posição de esvaziamento total)

*Drain tap for containers.
(Push button in total emptying position)*

FL.900-1

Válvula em aço zincado para drenagem de óleos, com cabeça cônica
Zinc plated steel grease drain valve with conical head

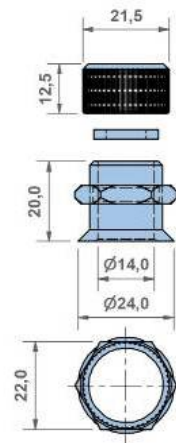

GR.500

Válvula lava copos em latão cromado com cruzeta em poliamida (PA)
Chrome plated glass rinser valve with polyamide (PA) star disk

