

HINGE

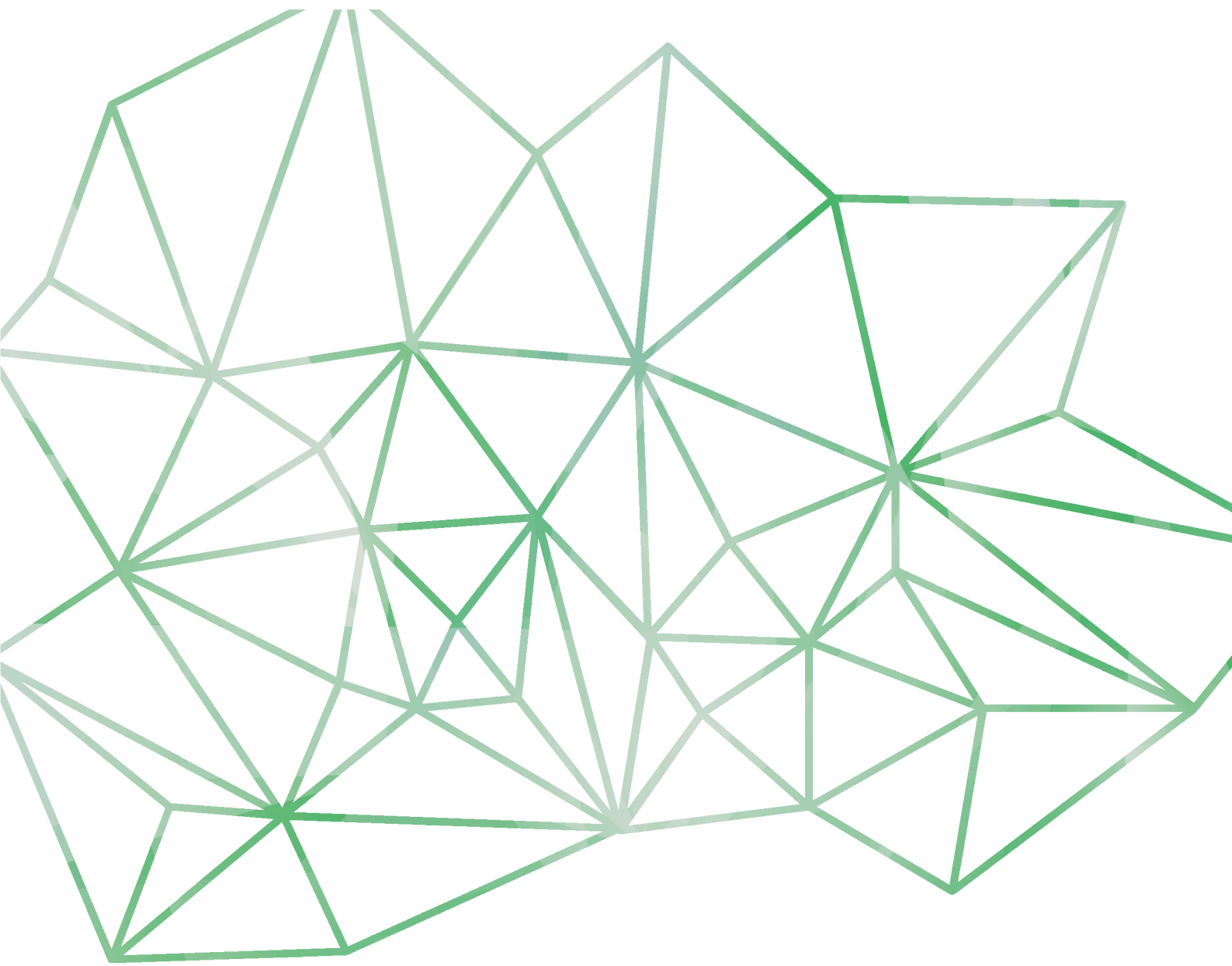

DOBB



02

DOBRADIÇAS
HINGES



ADICIAS



36	DOBRADIÇAS VERTICAIS <i>VERTICAL HINGES</i>
44	DOBRADIÇAS HORIZONTAIS <i>HORIZONTAL HINGES</i>
45	DOBRADIÇAS PARA ARCAS <i>HINGES FOR HORIZONTAL CHEST FREEZERS</i>
46	DOBRADIÇAS PIVÔ <i>PIVOT HINGES</i>
54	DOBRADIÇAS COM BARRA DE TORÇÃO <i>HINGES WITH TORSION BAR</i>
56	SUPORTES <i>SUPPORTS</i>
78	DOBRADIÇAS VAI-VEM <i>HINGES FOR SWINGING DOORS</i>
80	OUTRAS DOBRADIÇAS <i>OTHER HINGES</i>
82	ACESSÓRIOS PARA DOBRADIÇAS <i>HINGE ACCESSORIES</i>

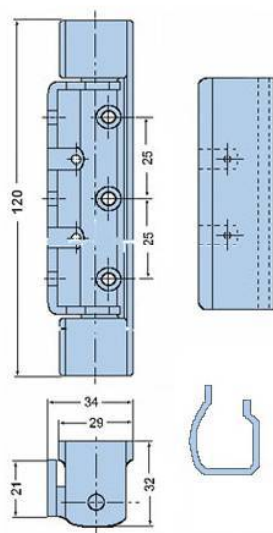

DB.400

0,225

Dobradiça vertical **s/mola** de 120mm, zamak 5 cromado
Com capa em ABS preto
Suplemento plástico AC.1145 (Pg. 83) incluído

Opção: AC.1146 (Pg. 83)

Chrome plated zamak 5, 120mm vertical hinge, **without spring** With black ABS cap
Plastic supplement AC.1145 (Pg. 83) included

Option: AC.1146 (Pg. 83)

DB.401

0,230

Dobradiça vertical **c/mola** de 120mm, zamak 5 cromado
Com capa em ABS preto
Suplemento plástico Ac.1145 (Pg. 83) incluído

Opção: AC.1146 (Pg. 83)

Chrome plated zamak 5, 120mm vertical hinge, with automatic return spring
With black ABS cap
Plastic supplement AC.1145 (Pg. 83) included

Option: AC.1146 (Pg. 83)

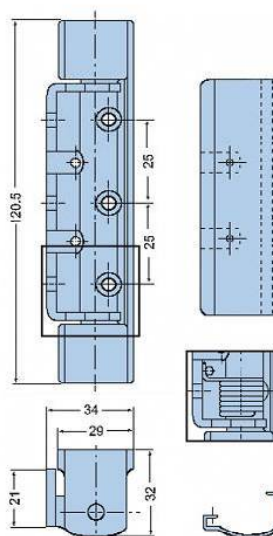

DB.402

0,230

Dobradiça vertical **s/mola** de 120mm, zamak 5 cromado
Com capa em Aço Inoxidável
Suplemento plástico Ac.1145 (Pg. 83) incluído

Opção: AC.1146 (Pg. 83)

Chrome plated zamak 5, 120mm vertical hinge, **without spring** With Stainless Steel cap
Plastic supplement AC.1145 (Pg. 83) included

Option: AC.1146 (Pg. 83)

DB.403

0,240

Dobradiça vertical **c/mola** de 120mm, zamak 5 cromado
Com capa em Aço Inoxidável
Suplemento plástico Ac.1145 (Pg. 83) incluído

Opção: AC.1146 (Pg. 83)

Chrome plated zamak 5, 120mm vertical hinge, with automatic return spring
With Stainless Steel cap
Plastic supplement AC.1145 (Pg. 83) included

Option: AC.1146 (Pg. 83)

DB.404

 0,245

Dobradiça vertical **s/mola** de 134mm, em zamak 5 cromado
Com capa em Aço Inoxidável
Suplemento plástico Ac.1147 (Pg. 84) incluído

Chrome plated zamak 5, 134mm vertical hinge, **without**

spring With Stainless Steel cap

Plastic supplement AC.1147 (Pg. 84) included

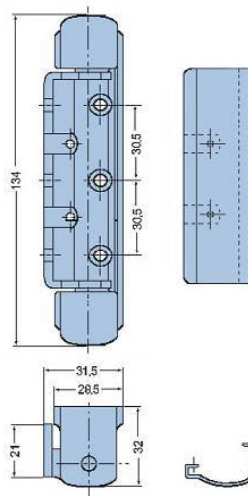

DB.410

 0,235

Dobradiça vertical 95mm, em zamak 5

Opção: AC.1144 (Pg. 83)

Chrome plated zamak 5, 95mm vertical hinge

Option: AC.1144 (Pg. 83)

A = 26MM | B = 30MM

DB.410 P

 0,210

Dobradiça vertical 95mm, em zamak 5

Opção: AC.1144 (Pg. 83)

Chrome plated zamak 5, 95mm vertical hinge

Option: AC.1144 (Pg. 83)

A = 26MM | B = 26MM

DB.410 G

 0,260

Dobradiça vertical 95mm, em zamak 5

Opção: AC.1144 (Pg. 83)

Chrome plated zamak 5, 95mm vertical hinge

Option: AC.1144 (Pg. 83)

A = 30MM | B = 26MM

DB.411

 0,225

Dobradiça vertical 96mm, em zamak 5

Opção: AC.1144 (Pg. 83)

Chrome plated zamak 5, 96mm vertical hinge

Option: AC.1144 (Pg. 83)

A = 24MM | B = 29MM

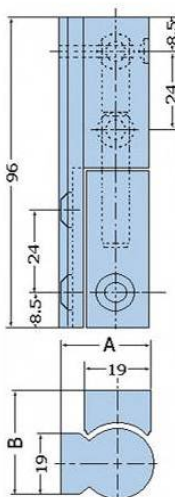
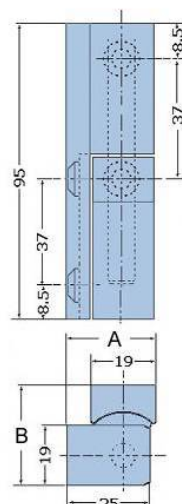

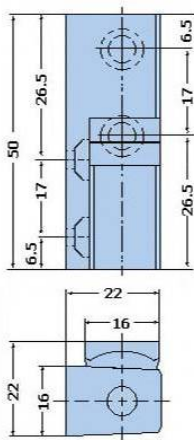

DB.412

0,080

Dobradiça vertical 50mm, em zamak 5 cromado
Opção: AC.1139 (Pg. 82)

*Chrome plated zamak 5, 50mm vertical hinge
Option: AC.1139 (Pg. 82)*

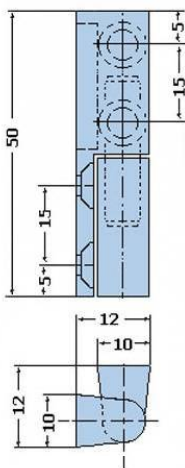

DB.413

0,035

Dobradiça vertical 50mm, em zamak 5 cromado
Chrome plated zamak 5, 50mm vertical hinge

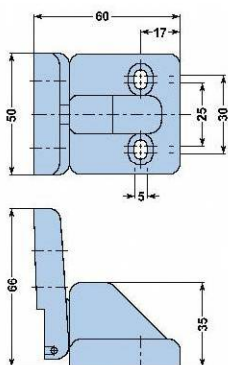

DB.415

0,060

Dobradiça para arcas frigoríficas horizontais em poliamida (PA) branca
Opção: AC.1141 (Pg. 82)

*White polyamide (PA) hinge for horizontal freezers
Option: AC.1141 (Pg. 82)*

DB.420 - DB.420 CR

 0,045

Dobradiça vertical 80mm, em poliamida (PA)

Opção: AC.1148 (Pg. 84)

Opção: Fiel em inox

Polyamide (PA), 80mm vertical hinge

Option: AC.1148 (Pg. 84)

Option: Stainless steel pin

DB.420 - Preto / Black

DB.420B - Branco / White

DB.420C - Cinza / Grey

DB.420CR - Creme / Beige

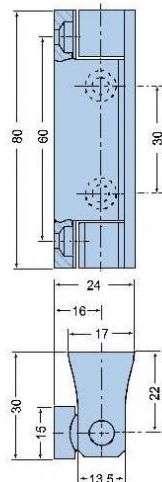

DB.421

 0,055

Dobradiça vertical 100mm, em poliamida (PA) preta

Opção: Fiel em inox

Black polyamide (PA), 100mm vertical hinge

Option: Stainless steel pin

DB.421 C

 0,055

Dobradiça vertical 100mm, em poliamida (PA) cinza

Opção: Fiel em inox

Grey polyamide (PA), 100mm vertical hinge

Option: Stainless steel pin

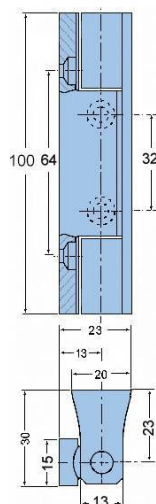

DB.425

 0,160

Dobradiça vertical 75mm, em zamak 5 cromado

Opção: Fiel em inox

Chrome plated zamak 5, 75mm vertical hinge

Option: Stainless steel pin

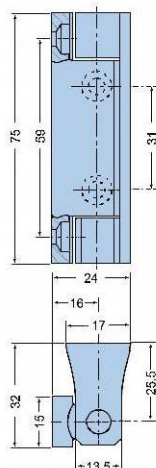

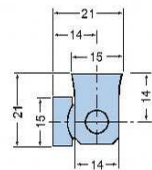
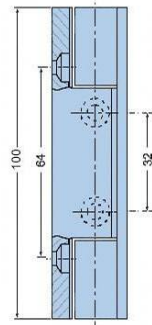

DB.430

0,135

Dobradiça vertical 100mm, em zamak 5 cromado

Opção: Fiel em inox

Chrome plated zamak 5, 100mm vertical hinge

Option: Stainless steel pin

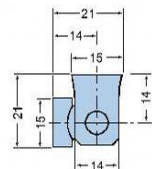
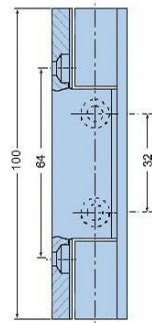

DB.431

0,095

Dobradiça vertical 100mm, em zamak 5 cromado e poliamida (PA)

Opção: Fiel em inox

Chrome plated zamak 5 and polyamide (PA), 100mm vertical hinge

Option: Stainless steel pin

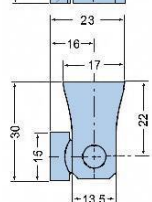
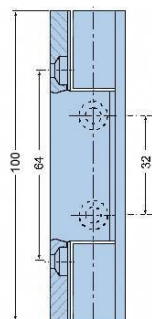

DB.435

0,165

Dobradiça vertical 100mm, em zamak 5 cromado

Opção: Fiel em inox

Chrome plated zamak 5, 100mm vertical hinge

Option: Stainless steel pin

DB.436

 0,110

Dobradiça vertical 100mm, em zamak 5 cromado e poliamida (PA)

Opção: Fiel em inox

Chrome plated zamak 5 and polyamide (PA), 100mm vertical hinge

Option: Stainless steel pin

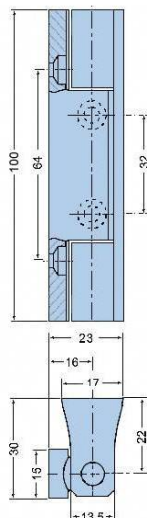

DB.437

 0,160

Dobradiça vertical 100mm, em zamak 5 cromado Com casquilhos em latão

Opção: Fiel em inox

Chrome plated zamak 5, 100mm vertical hinge With brass bushings

Option: Stainless steel pin

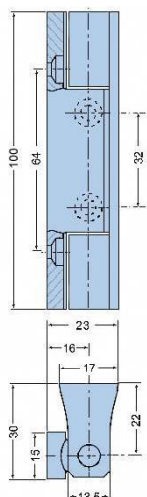

DB.440

 0,190

Dobradiça vertical 100mm, em zamak 5 cromado

Opção: Fiel em inox

Chrome plated zamak 5, 100mm vertical hinge

Option: Stainless steel pin

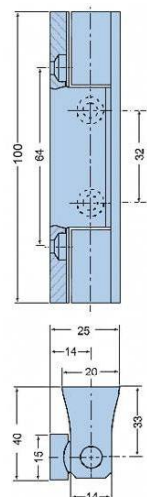

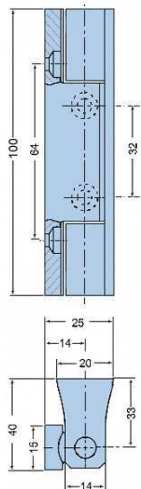

DB.441

0,145

Dobradiça vertical 100mm, em zamak 5 cromado e poliamida (PA)

Opção: Fiel em inox

Chrome plated zamak 5 and polyamide (PA), 100mm vertical hinge

Option: Stainless steel pin

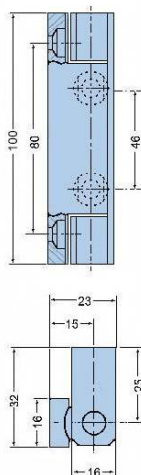

DB.445

0,175

Dobradiça vertical 100mm, em zamak 5 cromado

Opção: AC.1149 (Pg. 84)

Opção: Fiel em inox

Chrome plated zamak 5, 100mm vertical hinge

Option: AC.1149 (Pg. 84)

Option: Stainless steel pin

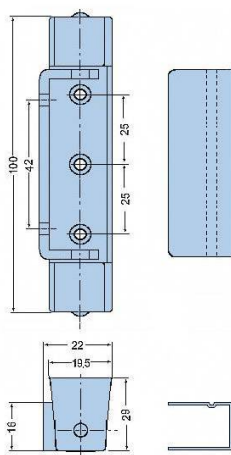

DB.450

0,170

Dobradiça vertical 100mm, em zamak 5 cromado com capa em aço inoxidável

Chrome plated zamak 5, 100mm vertical hinge with stainless steel clad

DB.454

 0,125

Dobradiça pequena em poliamida (PA) para porta frigorífica com fiel em Aço galvanizado
 Peso Porta (2 dobradiças) - 40Kgs máx
Opção: AC.1135 (Pg. 82)

Polyamide (PA) small hinge for refrigerator door with galvanized steel pin
Door weight (2 hinges) - 40Kgs max
Option: AC.1135 (Pg. 82)

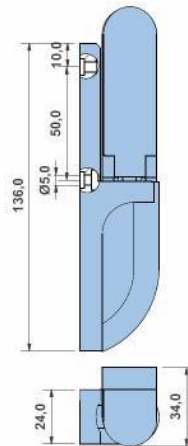

DB.455

 0,315

Dobradiça grande em poliamida (PA) com rampa para porta frigorífica com fiel em aço galvanizado
 Peso Porta (2 dobradiças) - 40Kgs máx
Opção: AC.1136 (Pg. 82)

Polyamide (PA) large hinge with ramp for fridge door with galvanized steel pin
Door weight (2 hinges) - 40Kgs max
Option: AC.1136 (Pg. 82)

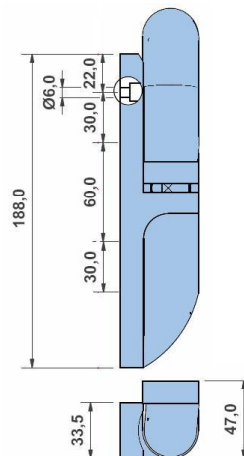

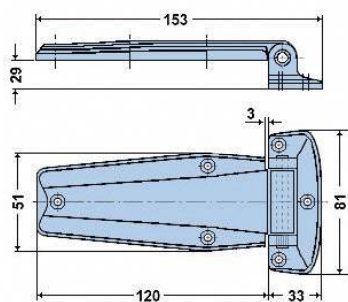

DB.470

 0,305

Dobradiça horizontal de 120mm em zamak 5 cromado
Intercambiável (Dir./Esq.)

*Chrome plated zamak 5, 120mm horizontal hinge
Interchangeable (Right/Left)*

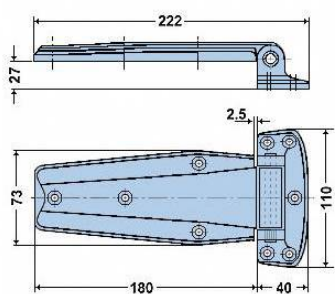

DB.471

 0,670

Dobradiça horizontal de 180mm em zamak 5 cromado
Intercambiável (Dir./Esq.)

*Chrome plated zamak 5, 180mm horizontal hinge
Interchangeable (Right/Left)*

DOB. DE ARCA - SELF BALACING HINGE

Dobradiça em aço galvanizado com capa branca em poliestireno, com várias forças, com ou sem mola para arcas frigoríficas horizontais

Opção: AC.1153 (Pg. 85)

Galvanized steel self balancing hinges with or without spring for horizontal chest freezer lids. With shock resistant white polystyrene cover

Option: AC.1153 (Pg. 85)



MOLA SPRING



Modelo	Mola (KG)	Força (KG)
DB.480	-	0.245
DB.481	Ø4.0	0.350
DB.482	Ø4.5	0.365
DB.483	Ø5.0	0.390
DB.484 *	Ø4.5	0.360
DB.485	Ø3.5	0.335
DB.488	Ø4.75	0.380

 * com mola forte
* with strong spring

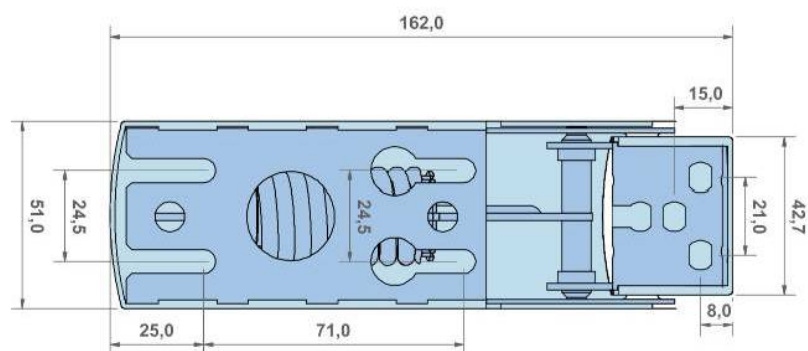

DOB. PIVÔ - PIVOT HINGE

Dobradiça pivô em zamak 5 niquelado com mola de retorno automático

Intercambiável (Dir./Esq.)

Pré-tensão de 15° com suportes compatíveis

Peso máx. da porta 25Kg, se for mais pesado, recomendam-se 2 dobradiças

Compatíveis com suportes:

DB.619 e DB.620

Opção: AC.1150 (Pg. 85)

*Nickel plated Zamak 5 pivot hinge with automatic return spring
Interchangeable (Right/Left)*

Pre-tension 15° with compatible supports

Door weight 25kg max., for heavy doors, two hinges are recommended

Compatible with supports:

DB.619 and DB.620

Option: AC.1150 (Pg. 85)

	MOLA SPRING	SUPORTE SUPPORT	A	B	KG
DB.474 G9	Ø2.8	QUADRADO SQUARE	109.0	9.0	0.200
DB.474 G	Ø2.8	QUADRADO SQUARE	113.5	13.5	0.200
DB.474 G9-1	Ø3.0	QUADRADO SQUARE	109.0	9.0	0.200
DB.474 G-1	Ø3.0	QUADRADO SQUARE	113.5	13.5	0.200

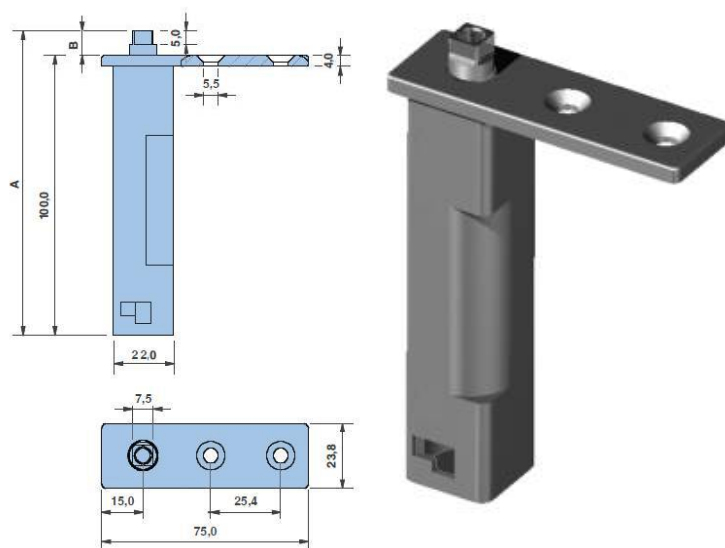

DOB. PIVÔ - PIVOT HINGE

Dobradiça pivô em zamak 5 niquelado com mola de retorno automático

Intercambiável (Dir./Esq.)

Pré-tensão de 15° com suportes compatíveis

Peso máx. da porta 25Kg, se for mais pesado, recomendam-se 2 dobradiças

Compatíveis com suportes:

DB.522-525 e DB.700-703

Opção: AC.1150 (Pg. 85)

*Nickel plated Zamak 5 pivot hinge with automatic return spring
Interchangeable (Right/Left)*

Pre-tension 15° with compatible supports

Door weight 25kg max., for heavy doors, two hinges are recommended

Compatible with supports:

DB.522-525 and DB.700-703

Option: AC.1150 (Pg. 85)

	MOLA SPRING	SUPORTE SUPPORT	A	B	KG
DV.2640	Ø2.8	QUADRADO SQUARE	111.7	11.7	0.200

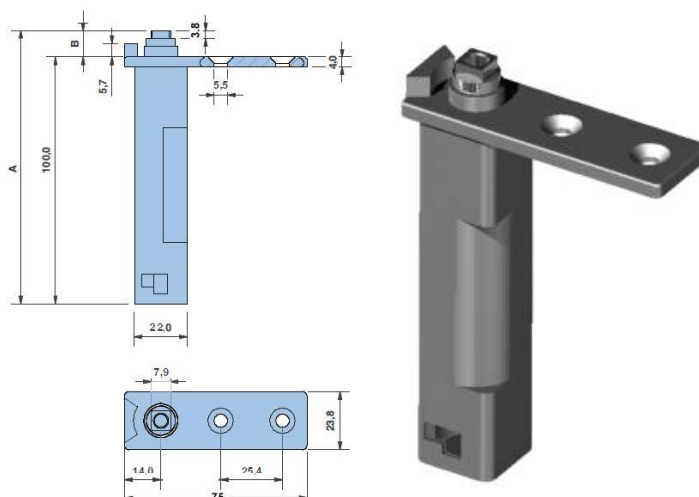

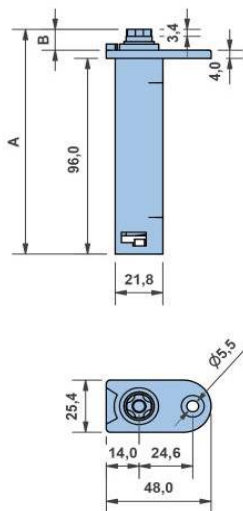

Novidade: Dobradiça com retorno a 45°
New: Hinge with return at 45°

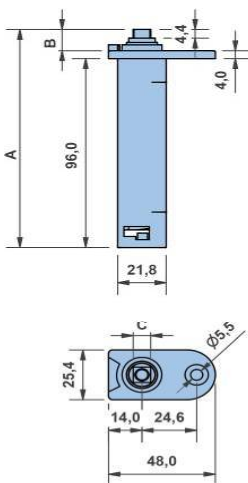

Novidade: Dobradiça com retorno a 45°
New: Hinge with return at 45°

DOB. PIVÔ - PIVOT HINGE

Dobradiça pivô em zamak 5 niquelado com mola de retorno automático

Suporte estrela

Intercambiável (Dir./Esq.), parafuso e anilha M6 incluídos

Pré-tensão de 15° com suportes compatíveis

Peso máx. da porta 25Kg, se for mais pesado, recomendam-se 2 dobradiças

Compatíveis com suportes:

DB.493, DB.494, DB.495, DB.498, DB.498P, DB.499, DB.501A, DB.502A, DB.515 e DB.516

Opção: AC.1150 (Pg. 85)

*Nickel plated Zamak 5 pivot hinge with automatic return spring
Star support*

Interchangeable (Right/Left), screw and washer M6 included

Pre-tension 15° with compatible supports

Door weight 25kg max., for heavy doors, two hinges are recommended

Compatible with supports

DB.493, DB.494, DB.495, DB.498, DB.498P, DB.499, DB.501A, DB.502A, DB.515 and DB.516

Option: AC.1150 (Pg. 85)

	MOLA SPRING	RETORNO RETURN	A	B	KG
DB.721-1	Ø3.0	90°	110.3	10.3	0.205
DB.720	Ø2.5	90°	110.3	10.3	0.190
DB.721	Ø2.8	90°	110.3	10.3	0.200
DB.733 *	Ø2.5	45°	110.3	10.3	0.190
DB.734-1 *	Ø2.8	45°	110.3	10.3	0.200
DB.734-1 *	Ø3.0	45°	110.3	10.3	0.205

DOB. PIVÔ - PIVOT HINGE

Dobradiça pivô em zamak 5 niquelado com mola de retorno automático

Suporte quadrado

Intercambiável (Dir./Esq.), parafuso e anilha M6 incluídos

Pré-tensão de 15° com suportes compatíveis

Peso máx. da porta 25Kg, se for mais pesado, recomendam-se 2 dobradiças

Compatíveis com suportes:

**DB.473/474 - DB.522-525, DB.700-703
DB.478 - DB.557-560, DB.515Q e DB.516Q
DV.2608 - DB.555-556**

Opção: AC.1150 (Pg. 85)

*Nickel plated Zamak 5 pivot hinge with automatic return spring
Square support*

Interchangeable (Right/Left), screw and washer M6 included

Pre-tension 15° with compatible supports

Door weight 25kg max., for heavy doors, two hinges are recommended

Compatible with supports:

**DB.473/474 - DB.522-525, DB.700-703
DB.478 - DB.557-560, DB.515Q and DB.516Q
DV.2608 - DB.555-556**

Option: AC.1150 (Pg. 85)

	MOLA SPRING	RETORNO RETURN	A	B	C	KG
DB.740	Ø2.5	90°	110.8	10.8	7.9	0.205
DB.741	Ø2.8	90°	110.8	10.8	7.9	0.190
DB.742	Ø2.8	90°	111.3	11.3	7.6	0.200
DB.743	Ø2.8	90°	108.5	8.3	7.6	0.200
DB.730 *	Ø2.5	45°	108.5	8.3	7.6	0.190
DB.731 *	Ø2.8	45°	108.5	8.3	7.6	0.200
DB.731-1 *	Ø3.0	45°	108.5	8.3	7.6	0.205

DOB. PIVÔ - PIVOT HINGE

Dobradiça pivô em zamak 5 niquelado com mola de retorno automático

Intercambiável (Dir./Esq.)

Pré-tensão de 15° com suportes compatíveis

Peso máx. da porta 25Kg, se for mais pesado, recomendam-se 2 dobradiças

Compatíveis com suportes:

DB.619 e DB.620

Opção: AC.1150 (Pg. 85)

*Nickel plated Zamak 5 pivot hinge with automatic return spring
Interchangeable (Right/Left)*

Pre-tension 15° with compatible supports

Door weight 25kg max., for heavy doors, two hinges are recommended

Compatible with supports:

DB.619 and DB.620

Option: AC.1150 (Pg. 85)

	MOLA SPRING	SUPORTE SUPPORT	A	B	KG
DB.745 G9	Ø2.8	QUADRADO SQUARE	109.0	9.0	0.200
DB.745 G	Ø2.8	QUADRADO SQUARE	113.5	13.5	0.200
DB.745 G9-1	Ø3.0	QUADRADO SQUARE	109.0	9.0	0.200
DB.745 G-1	Ø3.0	QUADRADO SQUARE	113.5	13.5	0.200

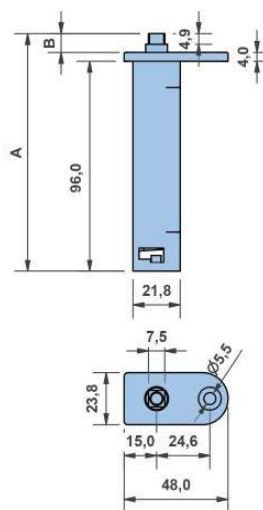

DOB. PIVÔ - PIVOT HINGE

Dobradiça pivô em zamak 5 niquelado com mola de retorno automático

Intercambiável (Dir./Esq.)

Pré-tensão de 15° com suportes compatíveis

Peso máx. da porta 25Kg, se for mais pesado, recomendam-se 2 dobradiças

Compatíveis com suportes:

DB.522-525 e DB.700-703

Opção: AC.1150 (Pg. 85)

*Nickel plated Zamak 5 pivot hinge with automatic return spring
Interchangeable (Right/Left)*

Pre-tension 15° with compatible supports

Door weight 25kg max., for heavy doors, two hinges are recommended

Compatible with supports:

DB.522-525 and DB.700-703

Option: AC.1150 (Pg. 85)

	MOLA SPRING	SUPORTE SUPPORT	A	B	*	KG
DB.750	Ø2.8	QUADRADO SQUARE	111.7	11.5		0.200
DB.751	Ø2.8	QUADRADO SQUARE	111.7	11.5	C/LAÇO	0.200
DB.752	Ø2.8	QUADRADO SQUARE	111.7	11.5	CAME 31	0.200

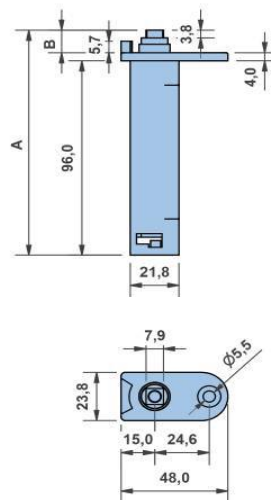

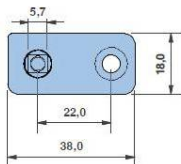
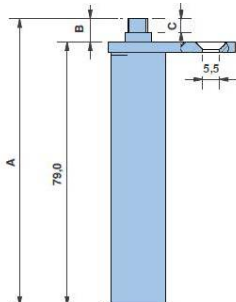

DOB. PIVÔ - PIVOT HINGE

Dobradiça pivô em zamak 5 niquelado com mola de retorno automático

Intercambiável (Dir./Esq.)

Pré-tensão de 15° com suportes compatíveis

Peso máx. da porta 12Kg, se for mais pesado, recomendam-se 2 dobradiças

Compatíveis com suportes:

DB.820-1 e DB.821-1 - DB.582, DB.649, DB.650, DB.651, DB.652, DB.655, DB.656, DB.659 e DB.660
DB.820-2 e DB.821-2 - DB.810-811

Opção: AC.801 (Pg. 85)

*Nickel plated Zamak 5 pivot hinge with automatic return spring
 Interchangeable (Right/Left)*

Pre-tension 15° with compatible supports

Door weight 12kg max., for heavy doors, two hinges are recommended

Compatible with supports:

DB.820-1 and DB.821-1 - DB.582, DB.649, DB.650, DB.651, DB.652, DB.655, DB.656, DB.659 and DB.660
DB.820-2 and DB.821-2 - DB.810-811

Option: AC.801 (Pg. 85)

MOLA SPRING

		A	B	C	 KG
DB.820	Ø2.0	84.0	4.9	1.4	0.090
DB.820-1	Ø2.0	85.0	6.0	2.5	0.090
DB.820-2	Ø2.0	86.5	7.5	4.0	0.090
DB.820-3	Ø2.2	87.5	8.5	5.0	0.100
DB.820-7	Ø2.2	90.0	11.0	5.0	0.105

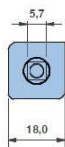
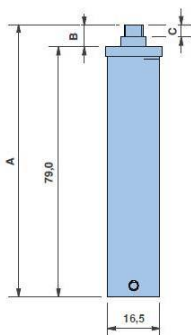
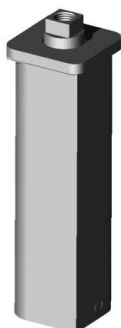

MOLA SPRING

		A	B	C	 KG
DB.821	Ø2.0	84.0	4.9	1.4	0.080
DB.821-1	Ø2.0	85.0	6.0	2.5	0.080
DB.821-2	Ø2.0	86.5	7.5	4.0	0.080
DB.821-3	Ø2.2	87.5	8.5	5.0	0.085

DB.855

Dobradiça em zamak 5 niquelada, com paragem 120°

Nickel plated zamak 5 hinge with stop at 120°

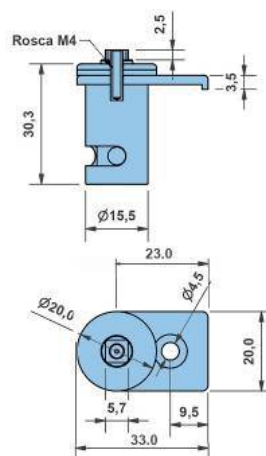

DOB. PIVÔ - PIVOT HINGE

Dobradiça pivô em zamak 5 niquelado com mola de retorno automático

Intercambiável (Dir./Esq.)

Pré-tensão de 15° com suportes compatíveis

Peso máx. da porta 25Kg, se for mais pesado, recomendam-se 2 dobradiças

Compatíveis com suportes:

DB.619 e DB.620

Nickel plated Zamak 5 pivot hinge with automatic return spring

Interchangeable (Right/Left)

Pre-tension 15° with compatible supports

Door weight 25kg max., for heavy doors, two hinges are recommended

Compatible with supports:

DB.619 and DB.620

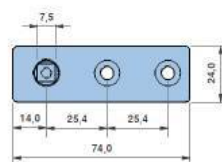
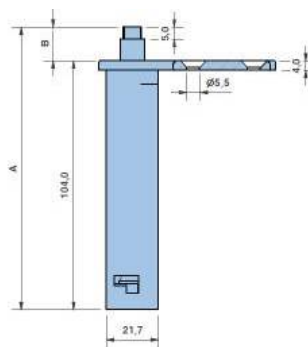

	MOLA SPRING	VEIO SHAFT	A	B	KG
DB.850	Ø2.8	AÇO STEEL	118.4	14.4	0.210
DB.850 A	Ø3.0	AÇO STEEL	118.4	14.4	0.215
DB.850 E	Ø2.8	AÇO STEEL	113.3	9.3	0.205

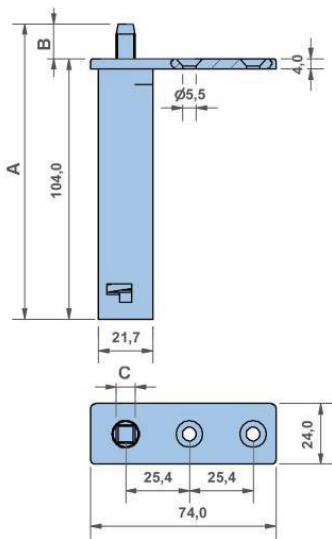

DOB. PIVÔ - PIVOT HINGE

Dobradiça pivô em zamak 5 niquelado com mola de retorno automático

Intercambiável (Dir./Esq.)

Pré-tensão de 15° com suportes compatíveis

Peso máx. da porta 25Kg, se for mais pesado, recomendam-se 2 dobradiças

Nickel plated Zamak 5 pivot hinge with automatic return spring

Interchangeable (Right/Left)

Pre-tension 15° with compatible supports

Door weight 25kg max., for heavy doors, two hinges are recommended

	MOLA SPRING	VEIO SHAFT	A	B	C	KG
DB.850 AG	Ø3.0	AÇO STEEL	118.5	14.0	7.35	0.215
DB.850 AG-3	Ø3.0	AÇO STEEL	118.5	14.0	7.30	0.215

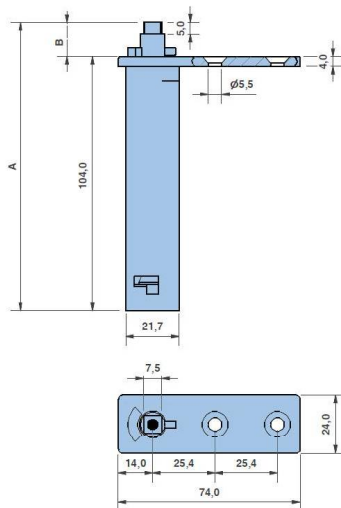

DOB. PIVÔ - PIVOT HINGE

Dobradiça pivô em zamak 5 niquelado com mola de retorno automático e batente

Intercambiável (Dir./Esq.)

Pré-tensão de 15° com suportes compatíveis

Peso máx. da porta 25Kg, se for mais pesado, recomendam-se 2 dobradiças

Compatíveis com suportes:

DB.619 e DB.620

Nickel plated Zamak 5 pivot hinge with automatic return spring and stopper

Interchangeable (Right/Left)

Pre-tension 15° with compatible supports

Door weight 25kg max., for heavy doors, two hinges are recommended

Compatible with supports:

DB.619 and DB.620

	MOLA SPRING	VEIO SHAFT	A	B	KG
DB.850 F	Ø2.8	AÇO STEEL	118.4	14.4	0.210
DB.850 EF	Ø2.8	AÇO STEEL	113.3	9.3	0.205
DB.850 AF	Ø3.0	AÇO STEEL	118.0	14.0	0.215

DV.2520

 0,255

Conjunto suporte pivô superior direito
Permite a passagem de um cabo até Ø6mm por dentro

*Right pivot bracket assembly
Allows for the passage of one cable Ø6mm*

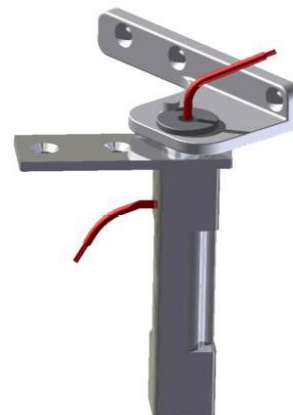
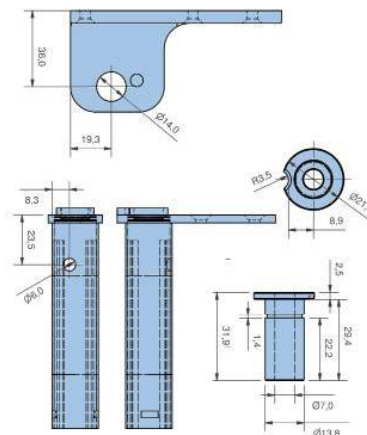

DV.2521

 0,255

Conjunto suporte pivô superior esquerdo
Permite a passagem de um cabo até Ø6mm por dentro

*Left pivot bracket assembly
Allows for the passage of one cable Ø6mm*

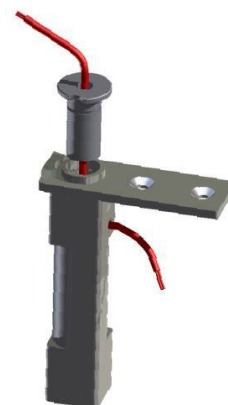
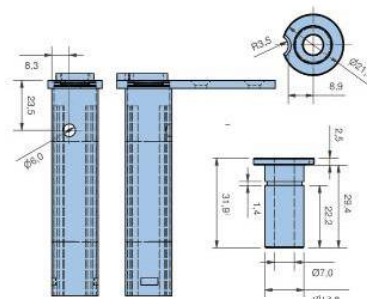

DV.2522

 0,145

Conjunto suporte pivô superior
Permite a passagem de um cabo até Ø6mm por dentro
(Suporte não incluído)

*Pivot bracket assembly
Allows for the passage of one cable Ø6mm
(Support not included)*

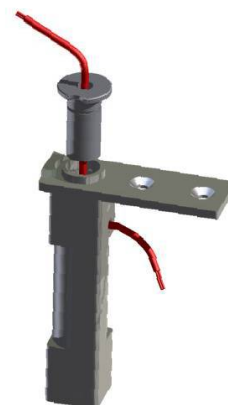
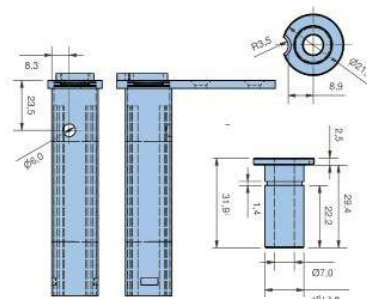

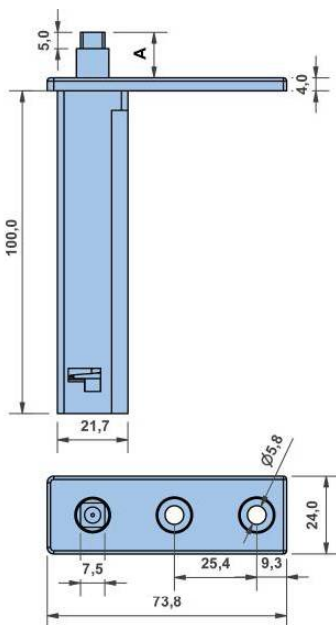

Dobradiça pivô com corpo em poliamida e mola de retorno automático
Intercambiável (Dir./Esq.)
Pré-tensão de 15° com suportes compatíveis
Peso máximo da porta 25 kg, se mais pesada, recomenda-se 2 dobradiças
Compatível com suportes: DB.619 e DB.620

*Pivot hinge with polyamide body and automatic return spring
Interchangeable (right/left)
Pre-tension 15° with compatible supports
Door weight 25kg max., for heavy doors, two hinges are recommended
Compatible with supports: DB.619 e DB 620*

DB.870 - DB.872

	MOLA SPRING	VEIO SHAFT	A	COR COLOUR	KG
DB.870	Ø2.8	AÇO STEEL	14.4	CINZA GREY	0.089
DB.870 P	Ø2.8	AÇO STEEL	14.4	PRETO BLACK	0.089
DB.870 A	Ø3.0	AÇO STEEL	14.4	CINZA GREY	0.094
DB.870 AP	Ø3.0	AÇO STEEL	14.4	PRETO BLACK	0.094
DB.870 E	Ø2.8	AÇO STEEL	9.3	CINZA GREY	0.084
DB.870 EP	Ø2.8	AÇO STEEL	9.3	PRETO BLACK	0.084
DB.872	Ø2.8	ZAMAK	14.0	CINZA GREY	0.099
DB.872A	Ø3.0	ZAMAK	14.0	CINZA GREY	0.099
DB.872 P	Ø2.8	ZAMAK	14.0	PRETO BLACK	0.099
DB.872 E	Ø2.8	ZAMAK	9.3	CINZA GREY	0.094
DB.872 EP	Ø2.8	ZAMAK	9.3	PRETO BLACK	0.094

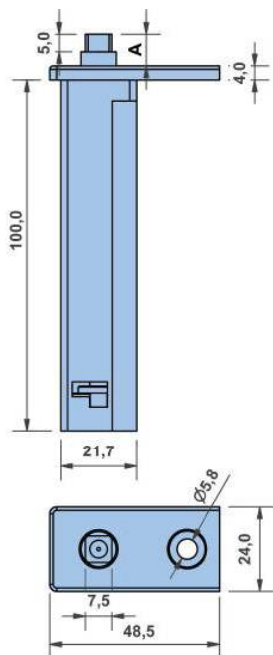

DB.871 - DB.873

	MOLA SPRING	VEIO SHAFT	A	COR COLOUR	KG
DB.871	Ø2.8	AÇO STEEL	14.4	CINZA GREY	0.081
DB.871 P	Ø2.8	AÇO STEEL	14.4	PRETO BLACK	0.081
DB.871 A	Ø3.0	AÇO STEEL	14.4	CINZA GREY	0.086
DB.871 AP	Ø3.0	AÇO STEEL	14.4	PRETO BLACK	0.086
DB.871 E	Ø2.8	AÇO STEEL	9.3	CINZA GREY	0.071
DB.871 EP	Ø2.8	AÇO STEEL	9.3	PRETO BLACK	0.071
DB.873	Ø2.8	ZAMAK	14.0	CINZA GREY	0.091
DB.873 P	Ø2.8	ZAMAK	14.0	PRETO BLACK	0.091
DB.873 E	Ø2.8	ZAMAK	9.3	CINZA GREY	0.081
DB.873 EP	Ø2.8	ZAMAK	9.3	PRETO BLACK	0.081

Dobradiça pivô com corpo em poliamida e mola de retorno automático
 Intercambiável (Dir./Esq.)
 Pré-tensão de 15° com suportes compatíveis
 Peso máximo da porta 25 kg, se mais pesada, recomenda-se 2 dobradiças

*Pivot hinge with polyamide body and automatic return spring
 Interchangeable (right/left)
 Pre-tension 15° with compatible supports
 Door weight 25kg max., for heavy doors, two hinges are recommended*

DB.870 AG

	MOLA SPRING	VEIO SHAFT	A	COR COLOUR	
DB.870 AG	Ø3.0	AÇO STEEL	14.0	CINZA GREY	0.094
DB.870 AG P	Ø3.0	AÇO STEEL	14.0	PRETO BLACK	0.094

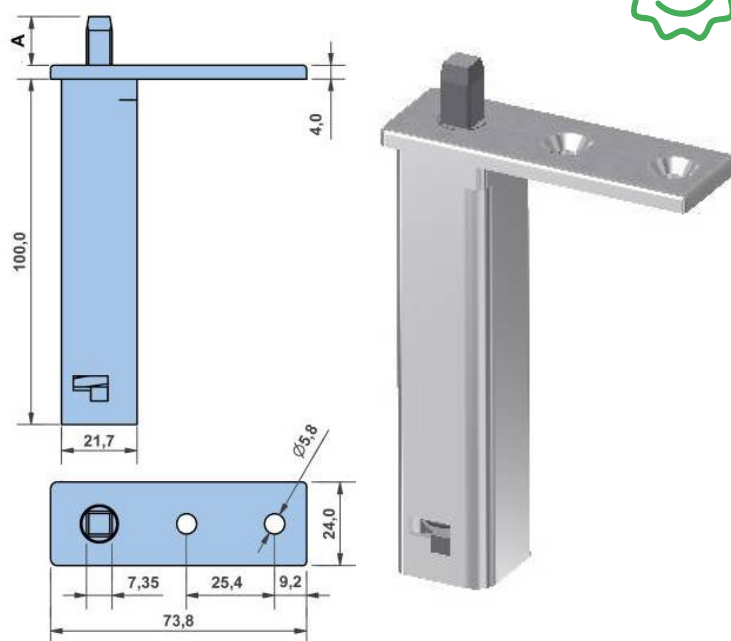

DB.871 AG

	MOLA SPRING	VEIO SHAFT	A	COR COLOUR	
DB.871 AG	Ø3.0	AÇO STEEL	14.0	CINZA GREY	0.086
DB.871 AG P	Ø3.0	AÇO STEEL	14.0	PRETO BLACK	0.086

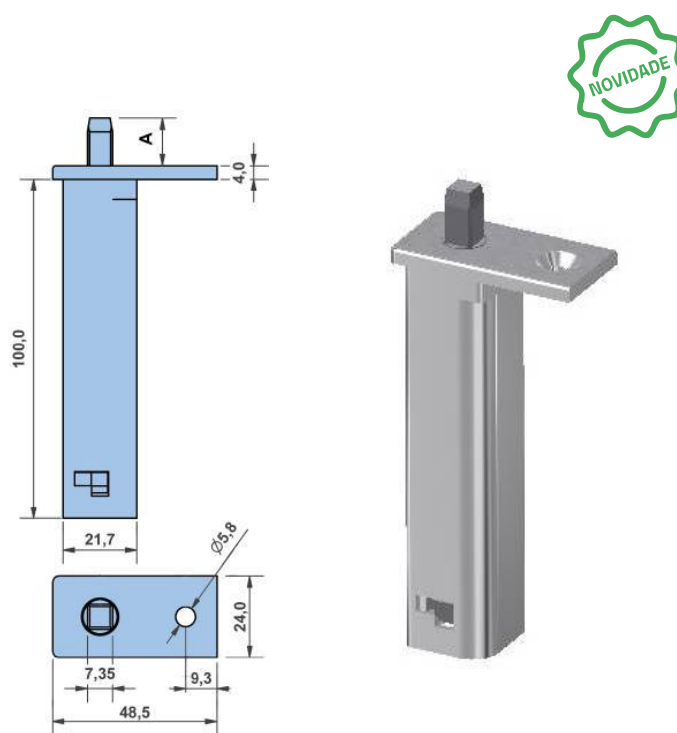



DB.350 - DB.370

Dobradiça com barra de torção para porta vertical de retorno automático, para abertura à direita ou à esquerda, com cabeça de seis furos e batente
Sugestão de montagem: pré-tensão a 60°
Peso máximo da porta: 30 Kg

*Hinge with torsion bar for vertical door with automatic return, for left or right opening, with six-holed head and stop pin
Assembly suggestion: pre-tension to 60°
Maximum door weight: 30 kg*

	MOLA 3X3 (L) SPRING 3X3 (L)	TUBO TUBE	SUPORTE SUPPORT	 KG
DB.350	630	600	A	0.190
DB.351	940	900	A	0.260
DB.352	1100	1050	A	0.295
DB.353	630	600	B	0.180
DB.354	940	900	B	0.250
DB.355	1100	1050	B	0.285
DB.356	630	600	C	0.205
DB.357	940	900	C	0.275
DB.358	1100	1050	C	0.310
DB.359	630	600	D	0.220
DB.360	940	900	D	0.290
DB.361	1100	1050	D	0.325
DB.362	630	600	E	0.220
DB.363	940	900	E	0.290
DB.364	1100	1050	E	0.325
DB.365	630	600	F	0.220
DB.366	940	900	F	0.290
DB.367	1100	1050	F	0.325
DB.368	630	600	G	0.220
DB.369	940	900	G	0.290
DB.370	1100	1050	G	0.325

SUPORTE . SUPPORT
A

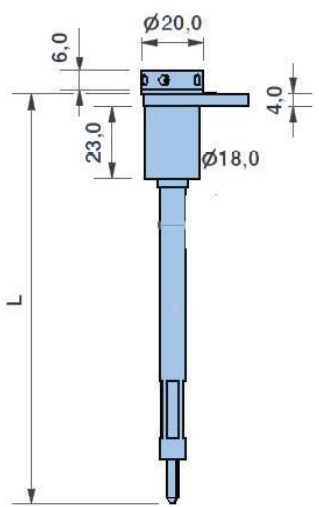

SUPORTE . SUPPORT
B

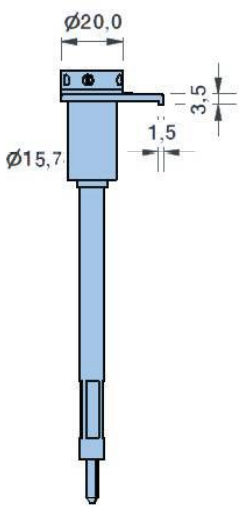

SUPORTE . SUPPORT
C

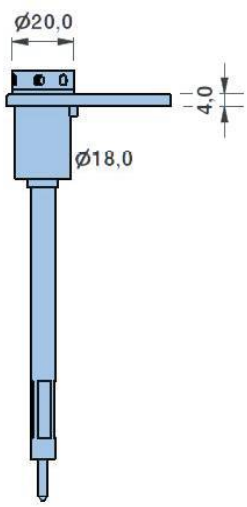

SUPORTE . SUPPORT
D

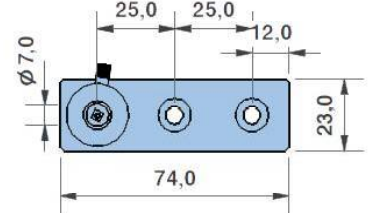
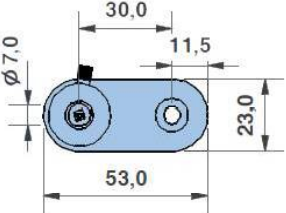
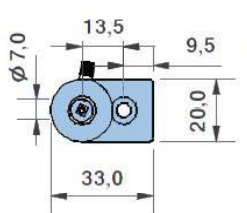
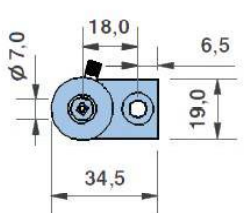
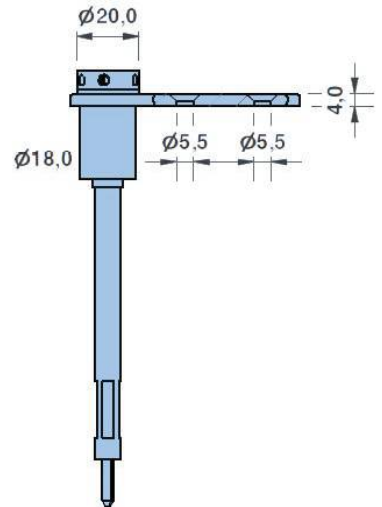

SUPORTE . SUPPORT
E

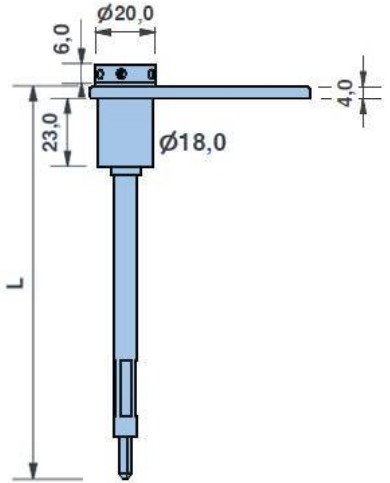

SUPORTE . SUPPORT
F

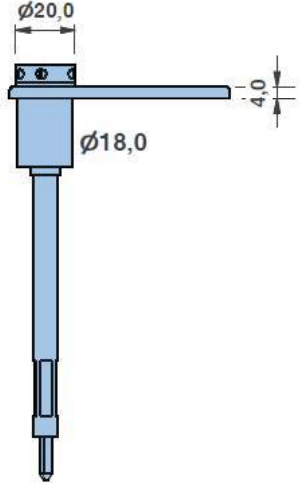

SUPORTE . SUPPORT
G

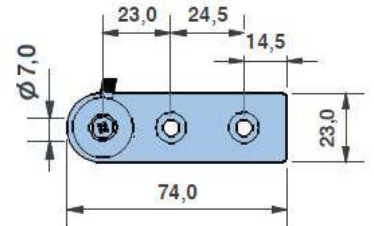
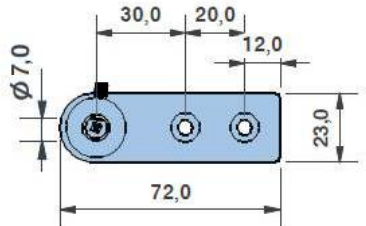
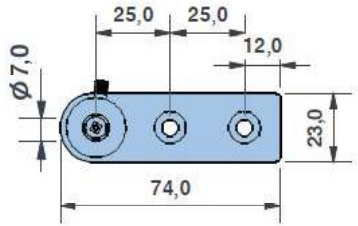
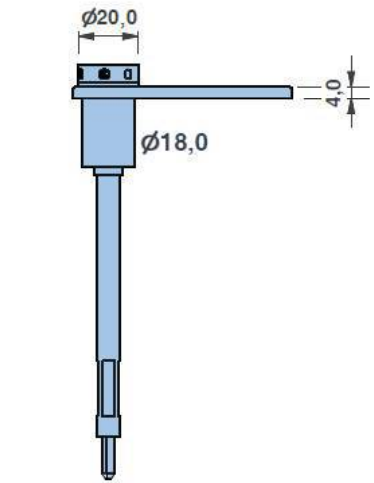

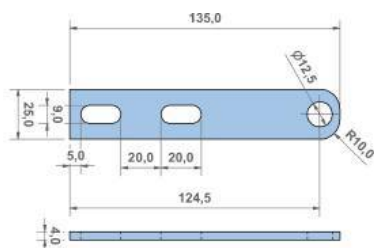

DB.491

RG 0,085

Suporte em Inox com furo de 12,5mm para porta

Stainless steel support for door with 12,5mm hole

DB.491-1

RG 0,085

Suporte em Inox com furo de 6mm para porta

Stainless steel support for door with 6mm hole

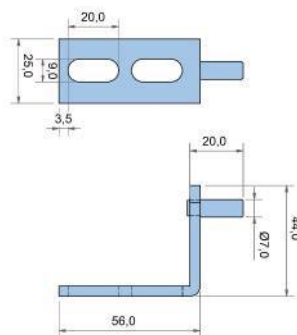

DB.492

RG 0,070

Suporte em Inox para porta

Stainless steel support for door

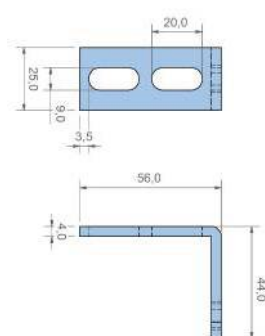

DB.493

RG 0,060

Suporte em Inox para pivô DB.475, DB.476, DB.468 e DB.831

Stainless steel support for DB.475, DB.476, DB.468 and DB.831 pivot hinge

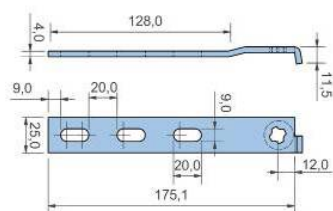

DB.494

RG 0,120

Suporte em Inox para pivô DB.475, DB.476, DB.468 e DB.831 (Superior Direito/Inferior Esquerdo)

Stainless steel support for DB.475, DB.476, DB.468 and DB.831 pivot hinge (Upper Right/Lower Left)

DB.495

0,120

Suporte em Inox para pivô DB.475, DB.476, DB.468 e DB.831 (Inferior Direito/Superior Esquerdo)

Stainless steel support for DB.475, DB.476, DB.468 and DB.831 pivot hinge (Lower Right/Upper Left)

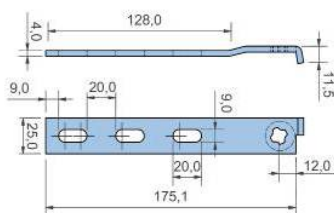
**DB.496**

0,130

Suporte em Inox para porta

Stainless steel support for door

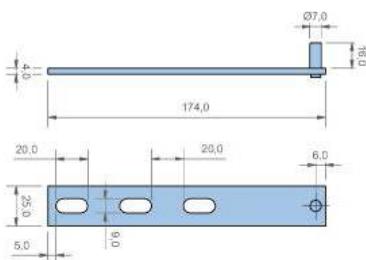
**DB.496 P**

0,070

Suporte pequeno em Inox para porta

Small Stainless steel support for door

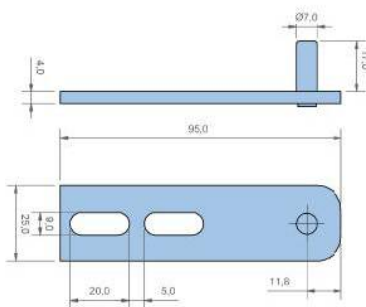
**DB.497**

0,120

Suporte em Inox para porta

Stainless steel support for door

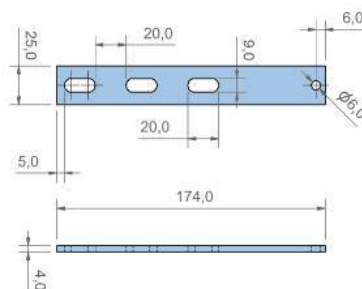

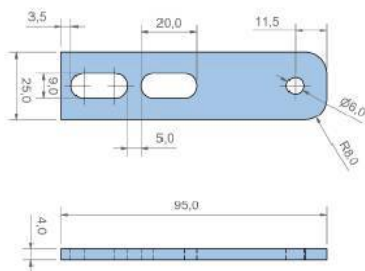

DB.497 P

0,060

Suporte pequeno em Inox para porta
Small Stainless steel support for door

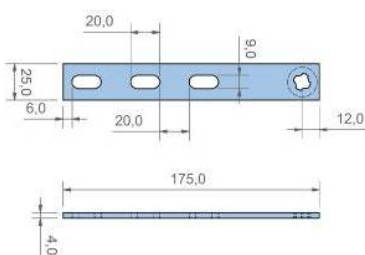

DB.498

0,120

Suporte em Inox para pivô DB.475, DB.476, DB.468 e DB.831

Stainless steel support for DB.475, DB.476, DB.468 and DB.831 pivot hinge

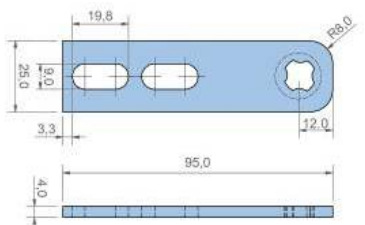

DB.498 P

0,060

Suporte em Inox para pivô DB.475, DB.476, DB.468 e DB.831

Stainless steel support for DB.475, DB.476, DB.468 and DB.831 pivot hinge

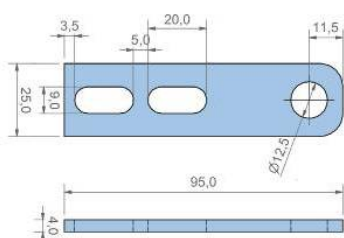

DB.498 PR

0,060

Suporte pequeno em Inox com furo Ø12,5 para porta
Small Stainless steel support with Ø12,5 hole for door

DB.499

0,085

Suporte em Inox para pivô DB.475, DB.476, DB.468 e DB.831

Stainless steel support for DB.475, DB.476, DB.468 and DB.831 pivot hinge

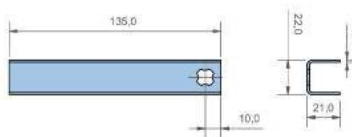
**DB.501 B - DB.502 B**

0,155

Conjunto de suportes para pivô em zamak 5 cromado, para porta direita

Zamak 5 chrome plated pivot hinge for right door

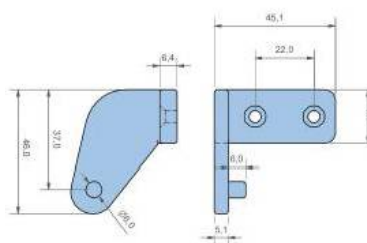

DB.501 B / DB.502 B



DB.501 B

DB.501 A

DB.501 A - DB.502 A

0,155

Conjunto de suportes para pivô em zamak 5 cromado, para porta esquerda

Zamak 5 chrome plated pivot hinge for left door

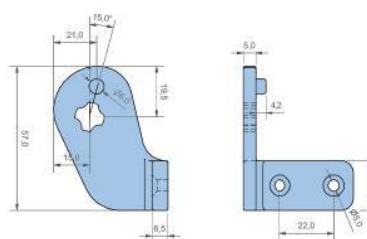

DB.501 A / DB.502 A



DB.502 B

DB.502 A



Opção de acabamento pintado sob consulta
Option of painted surface upon request

DB.510 CRO

0,065

Suporte em Zamak 5 cromado para porta frigorífica (Superior esquerdo/inferior direito)

Chrome plated zamak 5 fridge door rest (Upper left/lower right)

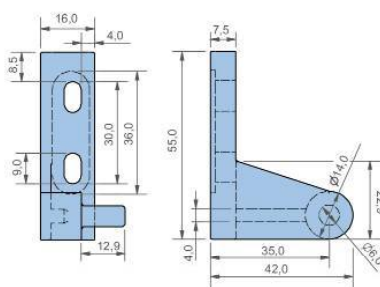

Opção de acabamento pintado sob consulta
Option of painted surface upon request

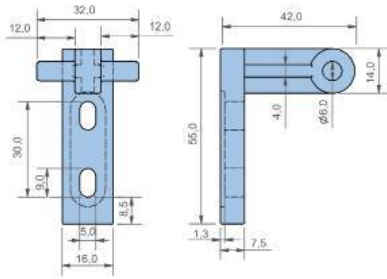

DB.511 CRO

0,055

Suporte em Zamak 5 cromado para porta frigorífica (Intermédio esquerdo/direito)

Chrome plated zamak 5 fridge door rest (Middle left/right)

Opção de acabamento pintado sob consulta
Option of painted surface upon request

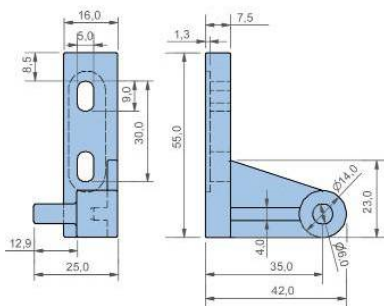

DB.512 CRO

0,060

Suporte em Zamak 5 cromado para porta frigorífica (Inferior esquerdo/superior direito)

Chrome plated zamak 5 fridge door rest (Lower left/upper right)

Opção de acabamento pintado sob consulta
Option of painted surface upon request

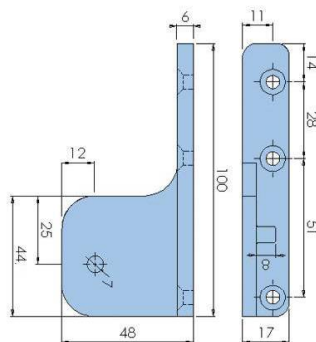

DB.513

0,155

Suporte em zamak 5 niquelado para porta (Inferior direito/superior esquerdo)

Opção: AC.1143 (Pg. 83)

Nickel plated zamak 5 bracket for door (Lower right/upper left)

Option: AC.1143 (Pg. 83)

DB.514

0,155

Suporte em zamak 5 niquelado para porta (Superior direito/inferior esquerdo)

Opção: AC.1143 (Pg. 83)

Nickel plated zamak 5 bracket for door (Upper right/lower left)

Option: AC.1143 (Pg. 83)

Opção de acabamento pintado sob consulta
Option of painted surface upon request

DB.515

0,115

Suporte em zamak 5 niquelado para pivô
DB.475, DB.476 e DB.478
 (Inferior direito/superior esquerdo)

Opção: AC.1143 (Pg. 83)

Nickel plated zamak 5 bracket for pivot hinge
DB.475, DB.476 and DB.478
 (Lower right/upper left)

Option: AC.1143 (Pg. 83)

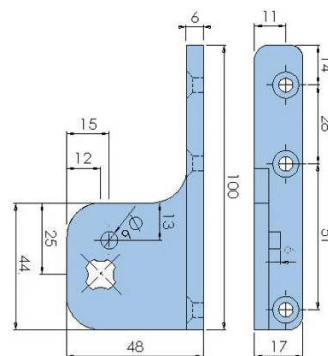

DB.515

DB.516

DB.516

0,115

Suporte em zamak 5 niquelado para pivô
DB.475, DB.476 e DB.478
 (Superior direito/inferior esquerdo)

Opção: AC.1143 (Pg. 83)

Nickel plated zamak 5 bracket for pivot hinge
DB.475, DB.476 and DB.478
 (Upper right/lower left)

Option: AC.1143 (Pg. 83)



Opção de acabamento pintado sob consulta
Option of painted surface upon request

DB.515 Q

0,115

Suporte em Zamak 5 niquelado para pivô; **DB.478**
 (Inferior direito/superior esquerdo)

Opção: AC.1143 (Pg. 83)

Nickel plated zamak 5 bracket for pivot hinge; DB.478
 (Lower right/upper left)

Option: AC.1143 (Pg. 83)

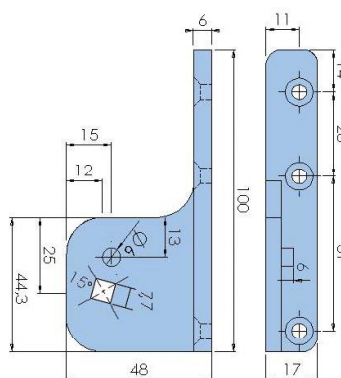

DB.515 Q

DB.516 Q

DB.516 Q

0,155

Suporte em Zamak 5 niquelado para pivô; **DB.478**
 (Superior direito/inferior esquerdo)

Opção: AC.1143 (Pg. 83)

Nickel plated zamak 5 bracket for pivot hinge; DB.478
 (Upper right/lower left)

Option: AC.1143 (Pg. 83)



Opção de acabamento pintado sob consulta
Option of painted surface upon request

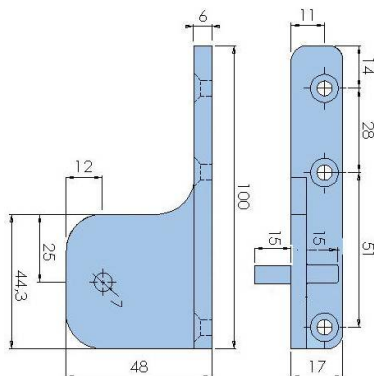

DB.538

0,125

Suporte intermédio em zamak 5 niquelado para porta direita

Opção: AC.1143 (Pg. 83)

Intermediate nickel plated zamak 5 bracket for right door

Option: AC.1143 (Pg. 83)

DB.539

0,125

Suporte intermédio em zamak 5 niquelado para porta esquerda

Opção: AC.1143 (Pg. 83)

Intermediate nickel plated zamak 5 bracket for left door

Option: AC.1143 (Pg. 83)



Opção de acabamento pintado sob consulta
Option of painted surface upon request

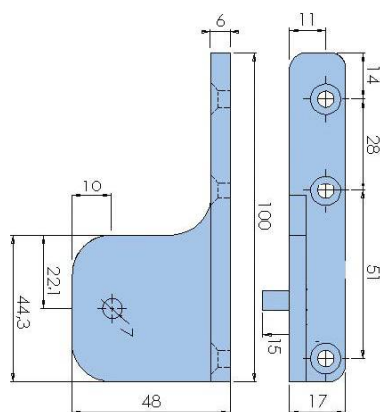

DB.540

0,120

Suporte em Zamak 5 niquelado para porta
(Inferior direito/superior esquerdo)

Opção: AC.1143 (Pg. 83)

*Nickel plated zamak 5 bracket for pivot hinge
(Lower right/upper left)*

Option: AC.1143 (Pg. 83)

DB.541

0,120

Suporte em Zamak 5 niquelado para porta
(Superior direito/inferior esquerdo)

Opção: AC.1143 (Pg. 83)

*Nickel plated zamak 5 bracket for pivot hinge
(Upper right/lower left)*

Option: AC.1143 (Pg. 83)



Opção de acabamento pintado sob consulta
Option of painted surface upon request

DB.555-2
 0,105

Suporte em Zamak 5 niquelado para pivô; **DV.2608**
(Inferior direito/superior esquerdo)

Altura pino = 3.5mm/Ao centro do quadrado= 12mm

Opção: AC.1143 (Pg. 83)

Nickel plated zamak 5 bracket for pivot hinge; DV.2608
(Lower right/upper left)

Pin height = 3.5mm/Till the center of square= 12mm

Option: AC.1143 (Pg. 83)

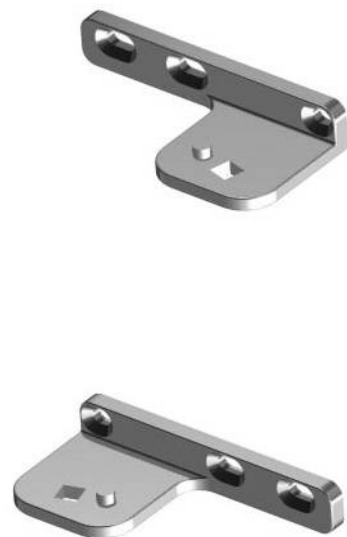
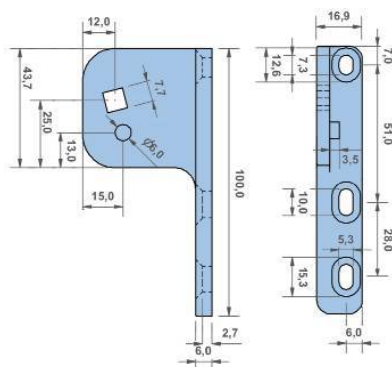
**DB.556-2**
 0,105

Suporte em Zamak 5 niquelado para pivô; **DV.2608**
(Superior direito/inferior esquerdo)

Altura pino = 3.5mm/Ao centro do quadrado= 12mm

Opção: AC.1143 (Pg. 83)

Nickel plated zamak 5 bracket for pivot hinge; DV.2608
(Upper right/lower left)

Pin height = 3.5mm/Till the center of square= 12mm

Option: AC.1143 (Pg. 83)



Opção de acabamento pintado sob consulta
Option of painted surface upon request

DB.557
 0,105

Suporte em Zamak 5 niquelado para pivô; **DB.478**
(Inferior direito/superior esquerdo)

Altura pino = 5mm/Ao centro do quadrado= 12mm

Opção: AC.1143 (Pg. 83)

Nickel plated zamak 5 bracket for pivot hinge; DB.478
(Lower right/upper left)

Pin height = 5mm/Till the center of square= 12mm

Option: AC.1143 (Pg. 83)

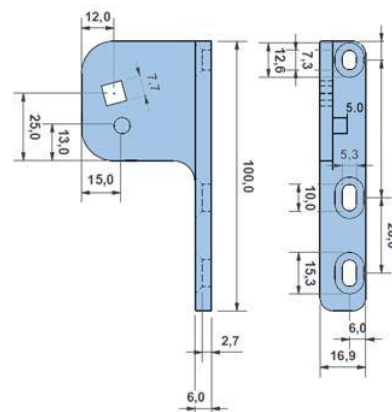
**DB.558**
 0,105

Suporte em Zamak 5 niquelado para pivô; **DB.478**
(Superior direito/inferior esquerdo)

Altura pino = 5mm/Ao centro do quadrado= 12mm

Opção: AC.1143 (Pg. 83)

Nickel plated zamak 5 bracket for pivot hinge; DB.478
(Upper right/lower left)

Pin height = 5mm/Till the center of square= 12mm

Option: AC.1143 (Pg. 83)



Opção de acabamento pintado sob consulta
Option of painted surface upon request

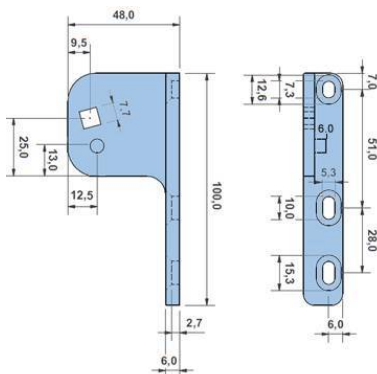

DB.559

0,115

Suporte em Zamak 5 niquelado para pivô; **DB.478**
(Inferior direito/superior esquerdo)
Altura pino = 6mm/Ao centro do quadrado= 9.5mm

Opção: AC.1143 (Pg. 83)

Nickel plated zamak 5 bracket for pivot hinge; DB.478
(Lower right/upper left)

Pin height = 6mm/Till the center of square= 9.5mm

Option: AC.1143 (Pg. 83)

DB.560

0,115

Suporte em Zamak 5 niquelado para pivô; **DB.478**
(Superior direito/inferior esquerdo)
Altura pino = 6mm/Ao centro do quadrado= 9.5mm

Opção: AC.1143 (Pg. 83)

Nickel plated zamak 5 bracket for pivot hinge; DB.478
(Upper right/lower left)

Pin height = 6mm/Till the center of square= 9.5mm

Option: AC.1143 (Pg. 83)



Opção de acabamento pintado sob consulta
Option of painted surface upon request

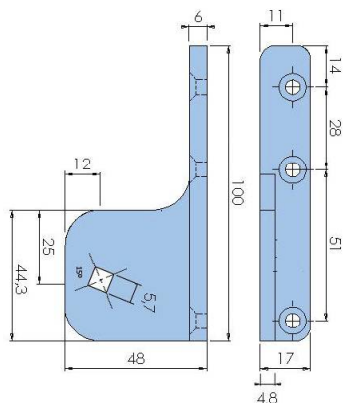
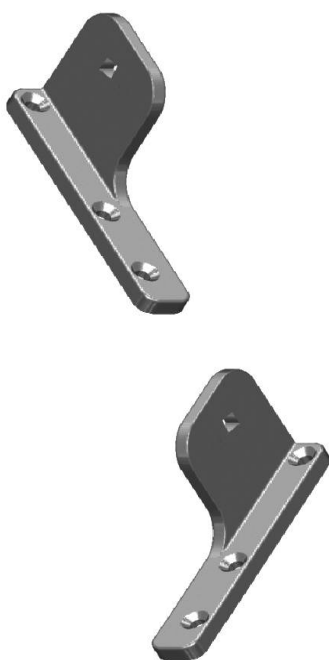

DB.810

0,115

Suporte em Zamak 5 niquelado para pivô
DB.802-2 e DB.821-2
(Inferior direito/superior esquerdo)

Opção: AC.1143 (Pg. 83)

Nickel plated zamak 5 bracket for pivot hinge
DB.802-2 e DB.821-2
(Lower right/upper left)

Option: AC.1143 (Pg. 83)

DB.811

0,115

Suporte em Zamak 5 niquelado para pivô
DB.802-2 e DB.821-2
(Superior direito/inferior esquerdo)

Opção: AC.1143 (Pg. 83)

Nickel plated zamak 5 bracket for pivot hinge
DB.802-2 e DB.821-2
(Upper right/lower left)

Option: AC.1143 (Pg. 83)



Opção de acabamento pintado sob consulta
Option of painted surface upon request

DV.2611
 0,115

Suporte em Zamak 5 niquelado com rosca M6 para porta
(Inferior direito/superior esquerdo)

Opção: AC.1143 (Pg. 83)

*Nickel plated zamak 5 bracket with M6 thread for door
(Lower right/upper left)*

Option: AC.1143 (Pg. 83)

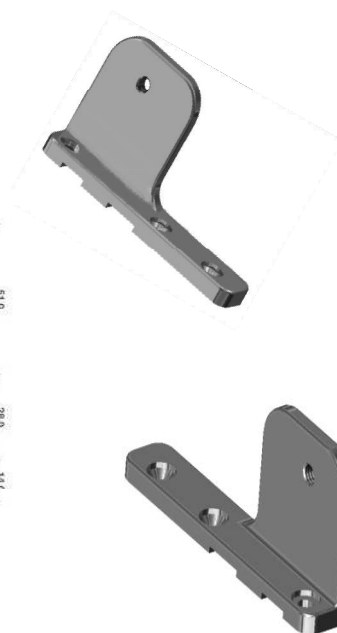
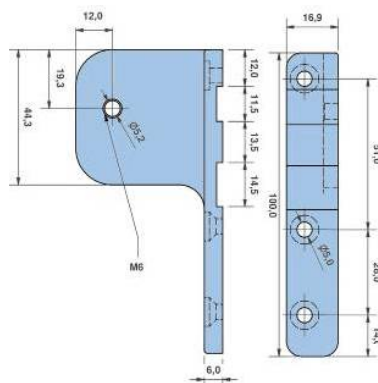
**DV.2612**
 0,115

Suporte em Zamak 5 niquelado com rosca M6 para porta
(Superior direito/inferior esquerdo)

Opção: AC.1143 (Pg. 83)

*Nickel plated zamak 5 bracket with M6 thread for door
(Upper right/lower left)*

Option: AC.1143 (Pg. 83)

DB.563 / DB.564
 0,115

Suporte em Zamak 5 niquelado com rosca M6 **sem rasgos** para porta
(Superior direito/inferior esquerdo)

Opção: AC.1143 (Pg. 83)

*Nickel plated zamak 5 bracket with M6 thread without rips for door
(Upper right/lower left)*

Option: AC.1143 (Pg. 83)



Opção de acabamento pintado sob consulta
Option of painted surface upon request

DB.522
 0,070

Suporte em aço cromado para pivô
DB.473, DB.474 e DV.2640
(Inferior direito/superior esquerdo)

*Chrome plated steel bracket for pivot
DB.473, DB.474 and DV.2640
(Lower right/upper left)*

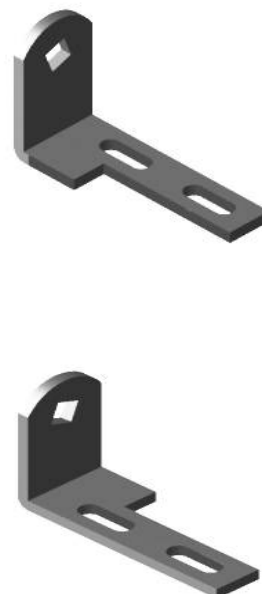
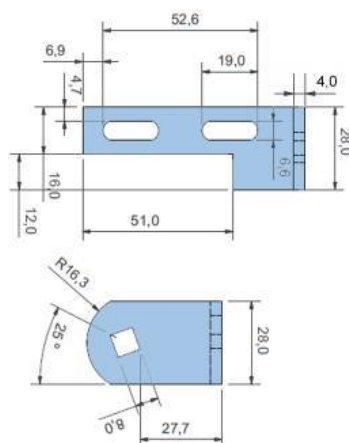
**DB.523**
 0,070

Suporte em aço cromado para pivô
DB.473, DB.474 e DV.2640
(Superior direito/inferior esquerdo)

*Chrome plated steel bracket for pivot
DB.473, DB.474 and DV.2640
(Upper right/lower left)*

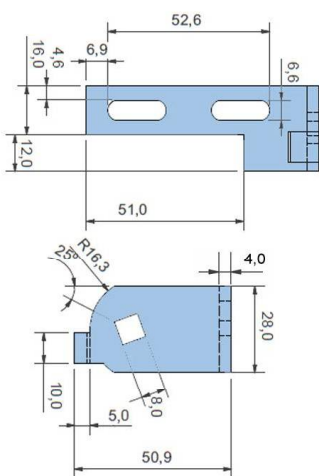

DB.524

0,075

Suporte em aço cromado para pivô
DB.473, DB.474 e DV.2640
(Inferior direito/superior esquerdo)

*Chrome plated steel bracket for pivot
DB.473, DB.474 and DV.2640
(Lower right/upper left)*

DB.525

0,075

Suporte em aço cromado para pivô
DB.473, DB.474 e DV.2640
(Superior direito/inferior esquerdo)

*Chrome plated steel bracket for pivot
DB.473, DB.474 and DV.2640
(Upper right/lower left)*

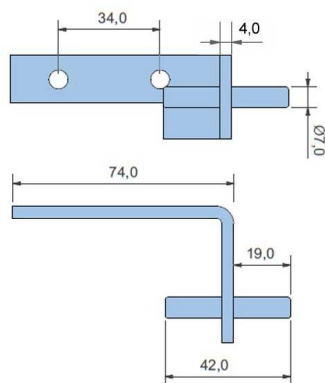

DB.526

0,085

Suporte em aço cromado para porta
(Intermédio direito)

*Chrome plated steel bracket for door
(Middle right)*

DB.527

0,085

Suporte em aço cromado para porta
(Intermédio esquerdo)

*Chrome plated steel bracket for door
(Middle left)*

DB.528

 0,085

Suporte em aço cromado para porta
(Inferior direito/superior esquerdo)

*Chrome plated steel bracket for door
(Lower right/upper left)*

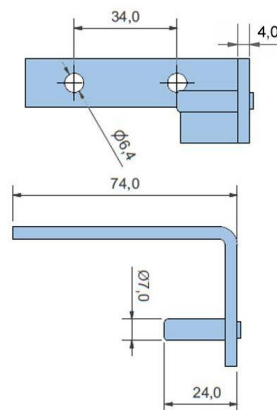

DB.529

 0,085

Suporte em aço cromado para porta
(Superior direito/inferior esquerdo)

*Chrome plated steel bracket for door
(Upper right/lower left)*

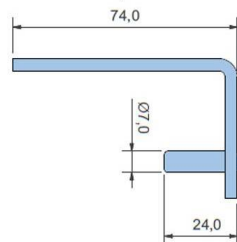

DB.531

 0,040

Suporte para porta frigorífica em aço galvanizado
(Superior direito/inferior esquerdo)

*Galvanized steel bracket for refrigerator door
(Upper right/lower left)*

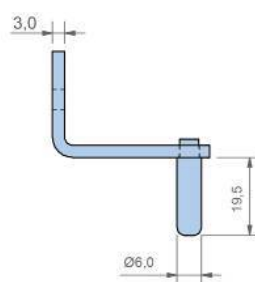

DB.532

 0,040

Suporte para porta frigorífica em aço galvanizado
(Inferior direito/superior esquerdo)

*Galvanized steel bracket for refrigerator door
(Lower right/upper left)*

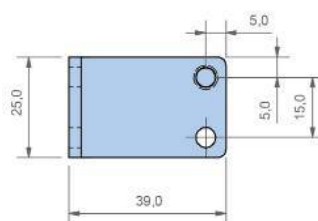

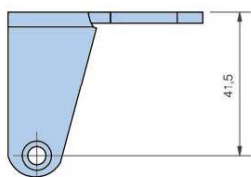
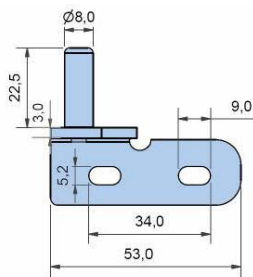

DB.533

0,045

Suporte para porta frigorífica em aço galvanizado (Superior direito)

Galvanized steel bracket for refrigerator door (Upper right)

DB.533-1

0,045

Suporte para porta frigorífica em aço galvanizado (Superior esquerdo)

Galvanized steel bracket for refrigerator door (Upper left)

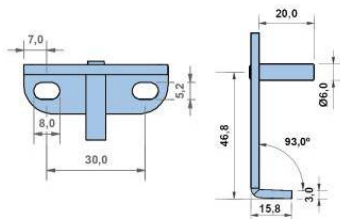
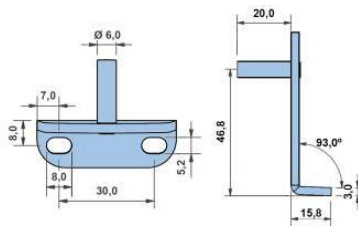

DB.580

0,070

Suporte em inox para porta

Stainless steel support for door rest

DB.581

0,070

Suporte em inox para porta

Stainless steel support for door rest

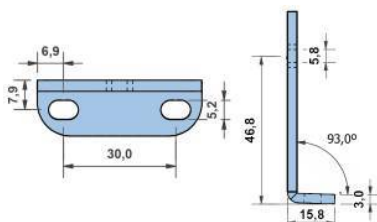

DB.582

0,060

Suporte em inox com quadra de 5.8mm para pivô DB.820-1 e DB.821-1

Stainless steel support with 5.8mm square for pivot hinge DB.820-1 e DB.821-1

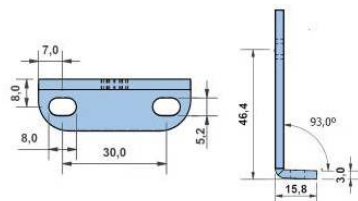

DB.583

0,060

Suporte em inox com estrela de 6mm para pivô DB.820-1 e DB.821-1

Stainless steel support with 6mm star for pivot hinge DB.820-1 e DB.821-1

DB.585

0,015

Suporte superior em inox para porta

Upper stainless steel support for door rest

DB.586

0,015

Suporte inferior em inox para porta

Lower stainless steel support for door rest

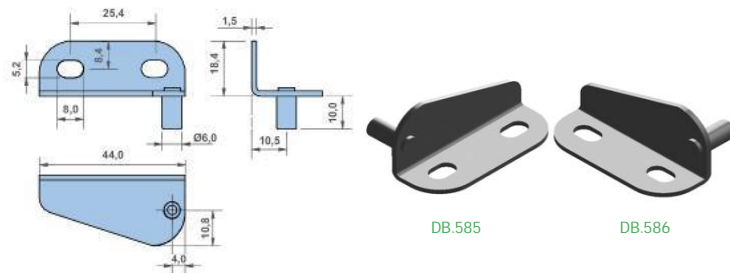

DB.585

DB.586

DB.585-1

0,015

Suporte superior em inox para porta

Upper stainless steel support for door rest

DB.586-1

0,015

Suporte inferior em inox para porta

Lower stainless steel support for door rest

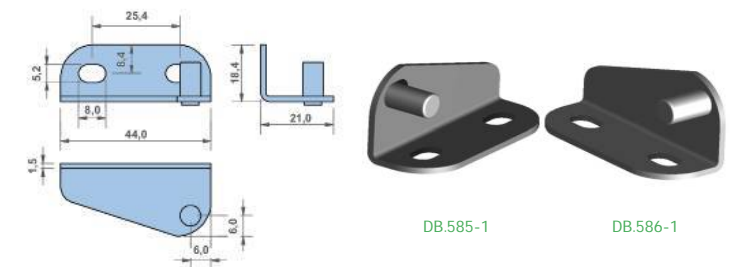

DB.585-1

DB.586-1

DB.620

0,220

Suporte aço galvanizado para pivô DB.474 G, DB.474 G9, DB.478, DV.2608, série DB.850 e série DB.870

Galvanized steel bracket for pivot hinge DB.474 G, DB.474 G9, DB.478, DV.2608, DB.850 series and DB.870 series

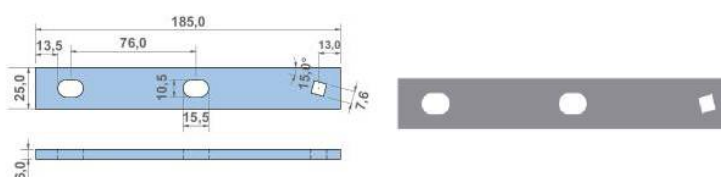

DB.621 - DB.621-1

0,230

Suporte aço galvanizado para porta

Galvanized steel support for door rest

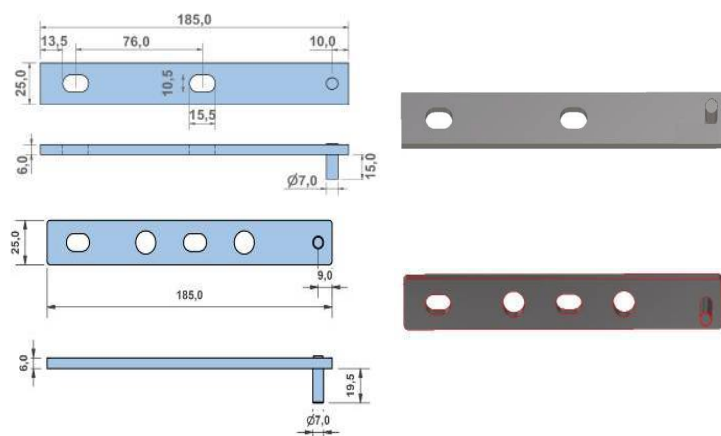

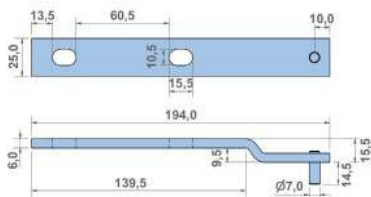

DB.622

0,230

Suporte aço galvanizado para porta
Galvanized steel support for door rest

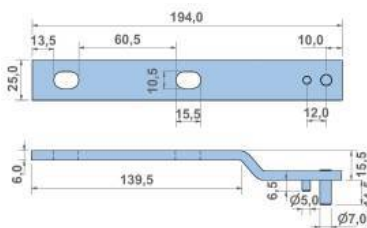

DB.623

0,235

Suporte aço galvanizado com batente para porta
Galvanized steel support for door rest with stopper

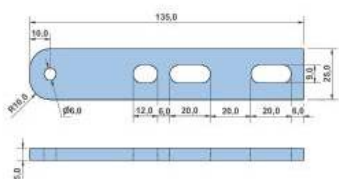

DB.691

0,140

Suporte inox para porta
Stainless steel support for door rest

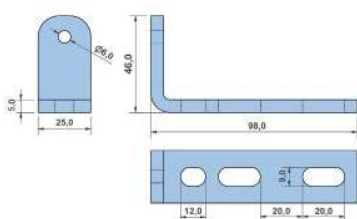

DB.691-1

0,140

Suporte inox para porta
Stainless steel support for door rest

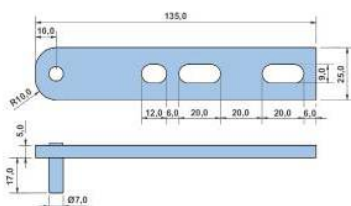

DB.692

0,145

Suporte inox para porta
Stainless steel support for door rest

DB.625 - DB.627

0,065

Suporte superior esquerdo/inferior direito para porta

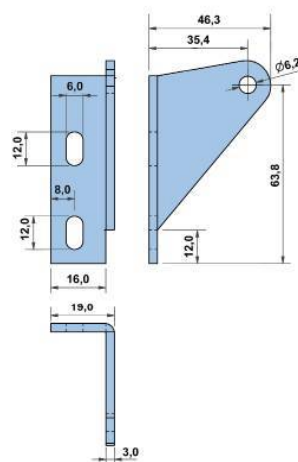
*Upper left/lower right bracket for door rest***DB.625** - Aço galvanizado / *galvanized steel***DB.627** - Inox / *stainless steel*DB.625
DB.627**DB.626 - DB.628**

0,065

Suporte superior direito/inferior esquerdo para porta

*Upper right/lower left bracket for door rest***DB.626** - Aço galvanizado / *galvanized steel***DB.628** - Inox / *stainless steel*DB.626
DB.628**DB.629 - DB.633**

0,065

Suporte superior direito/inferior esquerdo com pino e batente para porta

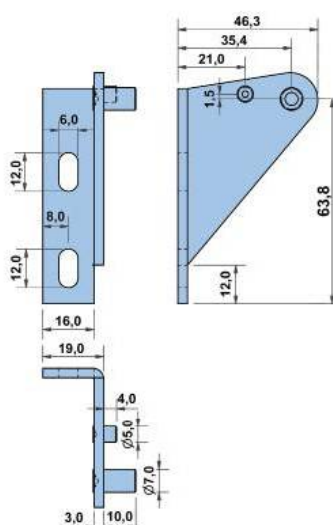
*Upper right/lower left with pin and stopper support for door***DB.629** - Aço galvanizado / *galvanized steel***DB.633** - Inox / *stainless steel*DB.629
DB.633**DB.630 - DB.634**

0,065

Suporte superior esquerdo/inferior direito com pino e batente para porta

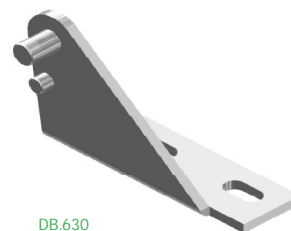
*Upper left/lower right with pin and stopper support for door***DB.630** - Aço galvanizado / *galvanized steel***DB.634** - Inox / *stainless steel*DB.630
DB.634

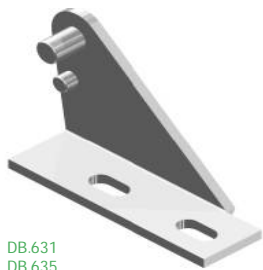

DB.631
DB.635

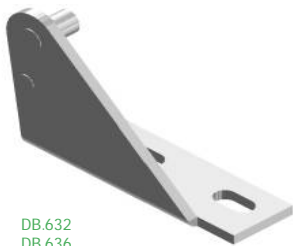

DB.632
DB.636

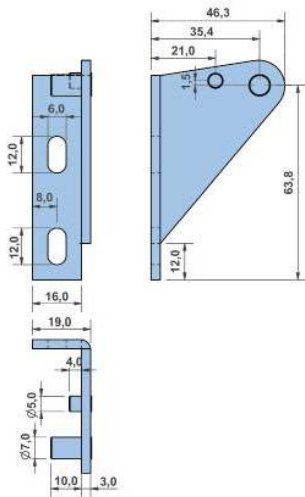

DB.631 - DB.635

0,065

Suporte superior esquerdo/inferior direito com pino e batente para porta

Upper left/lower right with pin and stopper support for door

DB.631 - Aço galvanizado / galvanized steel

DB.635 - Inox / stainless steel

DB.632 - DB.636

0,065

Suporte superior direito/inferior esquerdo com pino e batente para porta

Upper right/lower left with pin and stopper support for door

DB.632 - Aço galvanizado / galvanized steel

DB.636 - Inox / stainless steel



DB.637
DB.641



DB.638
DB.642

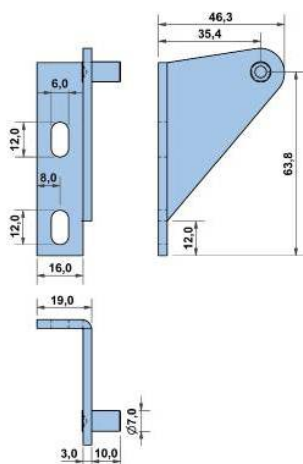

DB.637 - DB.641

0,065

Suporte superior direito/inferior esquerdo com pino para porta

Upper right/lower left with pin support for door

DB.637 - Aço galvanizado / galvanized steel

DB.641 - Inox / stainless steel

DB.638 - DB.642

0,065

Suporte superior esquerdo/inferior direito com pino para porta

Upper left/lower right with pin support for door

DB.638 - Aço galvanizado / galvanized steel

DB.642 - Inox / stainless steel

DB.639 - DB.643

0,065

Suporte superior esquerdo/inferior direito com pino para porta

Upper left/lower right with pin support for door

DB.639 - Aço galvanizado / *galvanized steel*

DB.643 - Inox / *stainless steel*

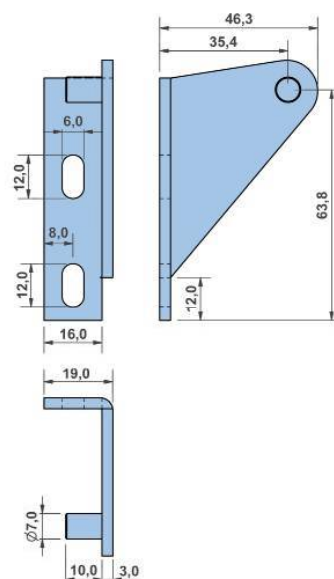

DB.639
DB.643



DB.640
DB.644

DB.640 - DB.644

0,065

Suporte superior direito/inferior esquerdo com pino para porta

Upper right/lower left with pin support for door

DB.640 - Aço galvanizado / *galvanized steel*

DB.644 - Inox / *stainless steel*

DB.645 - DB.647

0,065

Suporte intermédio com pino para porta esquerda

Middle support with pin for left door

DB.645 - Aço galvanizado / *galvanized steel*

DB.647 - Inox / *stainless steel*

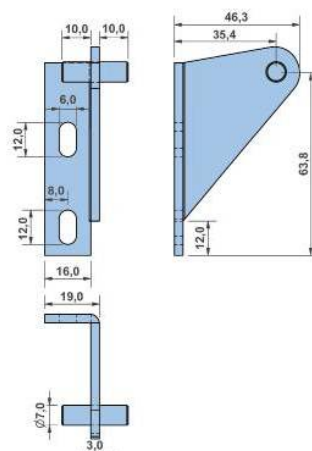

DB.645
DB.647

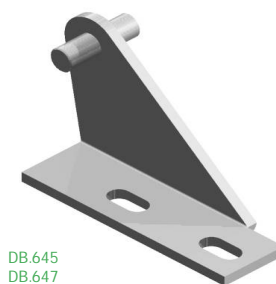
**DB.646 - DB.648**

0,065

Suporte intermédio com pino para porta direita

Middle support with pin for right door

DB.646 - Aço galvanizado / *galvanized steel*

DB.648 - Inox / *stainless steel*

DB.646
DB.648

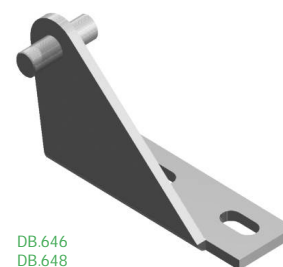



DB.649
DB.651



DB.650
DB.652

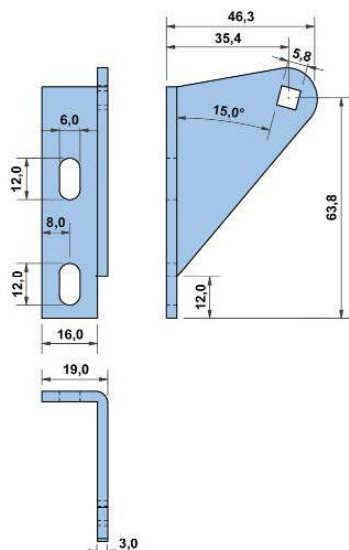

DB.649 - DB.651

0,060

Suporte superior esquerdo/inferior direito para pivô
DB.820-1 e DB.821-1

*Upper left/lower right support for pivot
DB.820-1 and DB.821-1*

DB.649 - Aço galvanizado / galvanized steel
DB.651 - Inox / stainless steel

DB.650 - DB.652

0,060

Suporte superior direito/inferior esquerdo para pivô
DB.820-1 e DB.821-1

*Upper right/lower left support for pivot
DB.820-1 and DB.821-1*

DB.650 - Aço galvanizado / galvanized steel
DB.652 - Inox / stainless steel

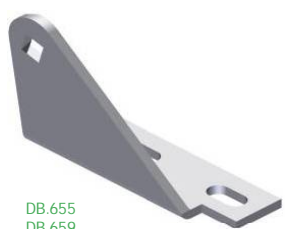

DB.655
DB.659



DB.656
DB.660

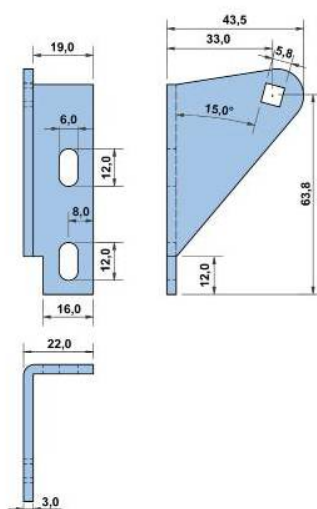

DB.655 - DB.659

0,060

Suporte superior direito/inferior esquerdo para pivô
DB.820-1 e DB.821-1

*Upper right/lower left support for pivot
DB.820-1 and DB.821-1*

DB.655 - Aço galvanizado / galvanized steel
DB.659 - Inox / stainless steel

DB.656 - DB.660

0,060

Suporte superior esquerdo/inferior direito para pivô
DB.820-1 e DB.821-1

*Upper left/lower right support for pivot
DB.820-1 and DB.821-1*

DB.656 - Aço galvanizado / galvanized steel
DB.660 - Inox / stainless steel

DB.657 - DB.661

 0,065

Suporte superior esquerdo/inferior direito com pino para porta

Upper left/lower right with pin support for pivot

DB.657 - Aço galvanizado / *galvanized steel*

DB.661 - Inox / *stainless steel*

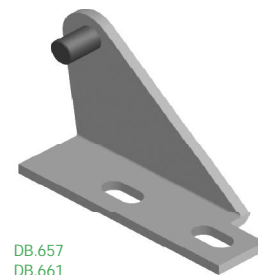
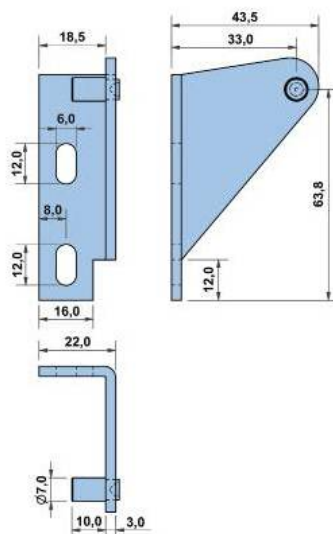

DB.657
DB.661

DB.658 - DB.662

 0,065

Suporte superior direito/inferior esquerdo com pino para porta

Upper right/lower left with pin support for pivot

DB.658 - Aço galvanizado / *galvanized steel*

DB.662 - Inox / *stainless steel*

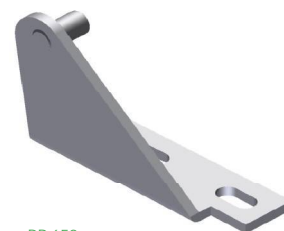

DB.658
DB.662

DB.700 - DB.700-2

 0,155

Suporte inferior direito em aço galvanizado para pivô DB.473, DB.474 e DV.2640

Lower right galvanized steel support for pivot DB. 473, DB.474 and DV.2640

	A
DB.700	11.5
DB.700-2	15.0
DB.700-22	13.0

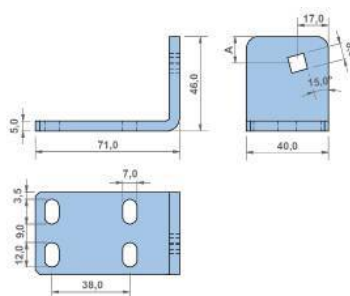

DB.701

 0,155

Suporte inferior esquerdo em aço galvanizado para pivô DB.473, DB.474 e DV.2640

Lower left galvanized steel support for pivot DB. 473, DB.474 and DV.2640

	A
DB.701	11.5



DB.700-1

 0,180

Suporte inferior direito em aço galvanizado com reforço para pivô DB.473, DB.474 e DV.2640

Lower right galvanized steel support with reinforcement for pivot DB.473, DB.474 and DV.2640

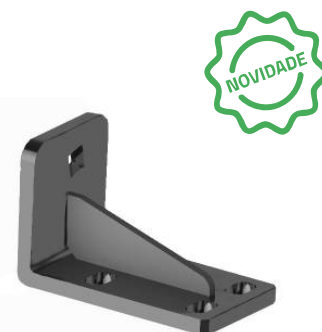
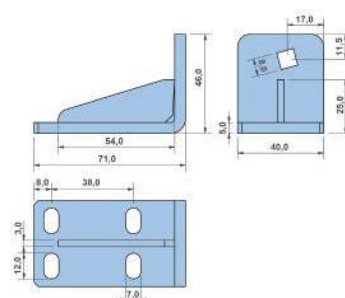

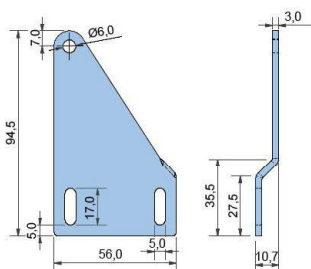
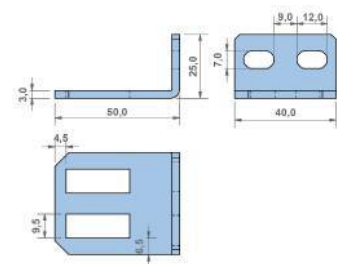
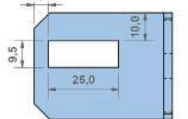
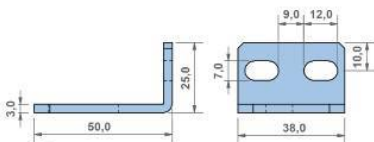
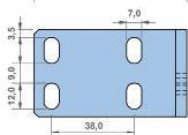
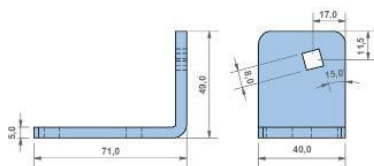

DB.702

0,160

Suporte inferior direito em aço galvanizado para pivô DB.473, DB.474 e DV.2640

Lower right galvanized steel support for pivot DB.473, DB.474 and DV.2640

DB.703

0,160

Suporte inferior esquerdo em aço galvanizado para pivô

Lower left galvanized steel support for pivot

DB.704

0,060

Suporte superior esquerdo em aço galvanizado para porta

Upper left galvanized steel support for door

DB.705

0,060

Suporte superior direito em aço galvanizado para porta

Upper right galvanized steel support for door

DB.706

0,050

Suporte superior em aço galvanizado para porta

Upper galvanized steel support for door

DB.708

0,085

Suporte superior em aço galvanizado para porta

Upper galvanized steel support for door

DB.616

 0,255

Suporte intermédio em aço cromado para porta
Note: Permite passagem de cabo

Intermediate chrome plated steel support for door
Note: Allows cable passage

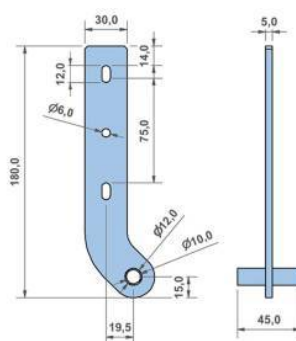

DB.617

 0,215

Suporte inferior direito em aço cromado para porta

Lower right chrome plated steel support for door

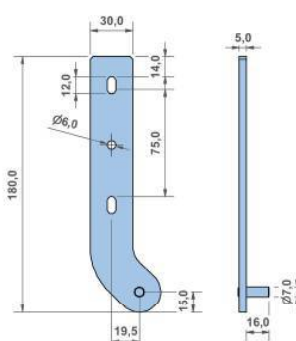

DB.618

 0,215

Suporte inferior esquerdo em aço cromado para porta

Lower left chrome plated steel support for door

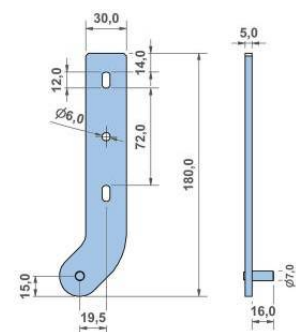

DB.619

 0,215

Suporte em aço cromado para pivô DB.474 G, DB.474 G9, DB.478, DV.2608, série DB.850 e série DB.870

Chrome plated steel support for pivot DB.474 G, DB.474 G9, DB.478, DV.2608, DB.850 series and DB.870 series

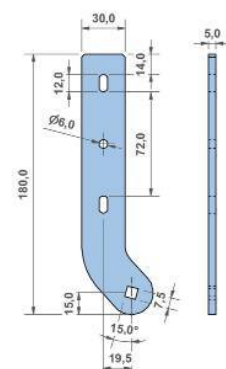

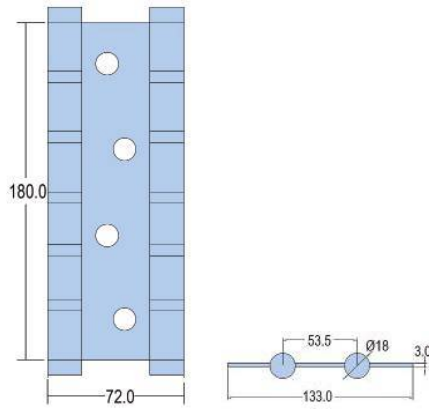

DB.611

RG 0,990

Dobradiça em Inox para portas vai-vem com mola e 10 rolamentos

Stainless steel hinge for swinging doors with spring and 10 bearings



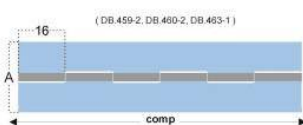
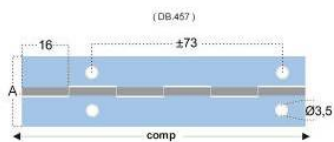
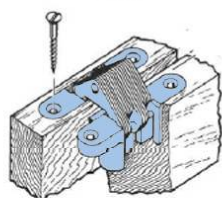
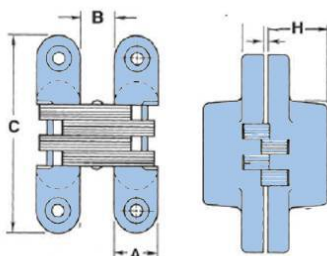
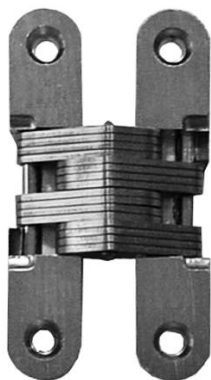
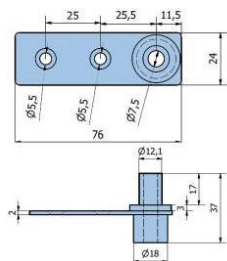
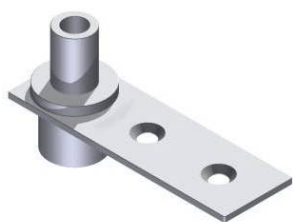
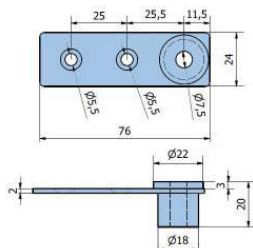

DB.380

0,050

Passa cabos (Ø6mm) simples em zamak 5 cromado

Simple chrome plated zamak 5 (Ø6mm) cable passage

DB.381

0,055

Passa cabos (Ø6mm) simples em zamak 5 cromado

Simple chrome plated zamak 5 (Ø6mm) cable passage

DB.680 - 686

Dobradiça invisível em inox para embutir

Invisible stainless steel hinge

	A (MM)	B (MM)	C (MM)	H (MM)	CARGA LOAD (KG)	
DB.680	12.7	9.0	45.0	17.0	10 KG	0.100
DB.681	13.0	9.0	60.0	18.0	20 KG	0.100
DB.682	15.8	12.0	70.0	23.0	22 KG	0.200
DB.683	19.0	13.0	95.0	27.0	20 KG	0.200
DB.684	25.4	17.0	118.0	36.0	40 KG	0.700
DB.685	28.5	20.0	118.0	41.0	50 KG	0.800
DB.686	34.0	27.0	139.0	50.0	60 KG	1.400

DB.457 - 463

Dobradiça plano em inox AISI 304

AISI 304 stainless steel flat hinge

	A (MM)	E (MM)	COMP./LENGTH (MM)	
DB.457 *	32	0.7	2000	0.185
DB.459-1	25.4	0.9	1829	0.490
DB.460-1	38	0.9	1829	0.660
DB.463	38	1.5	1820	1.130

DB.1790

 0,030

Dobradiça em inox para porta
Stainless steel hinge for door

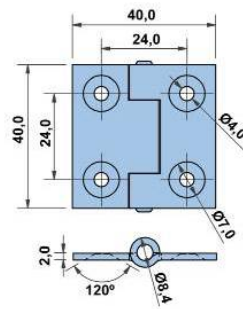

DB.1790-2

 0,020

Dobradiça em inox para porta
Stainless steel hinge for door

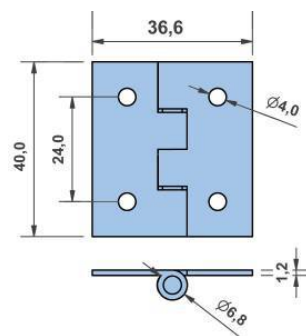

DB.1790-3

 0,020

Dobradiça de soldar em inox para porta
Welding stainless steel hinge for door

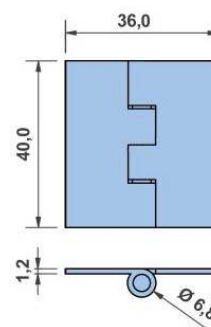

DB.1795

 0,020

Dobradiça em inox para porta
Stainless steel hinge for door

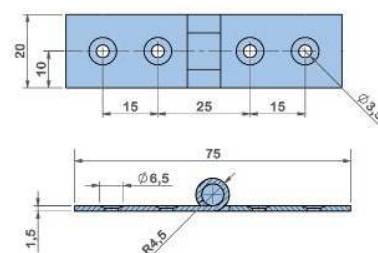



AC.1135 AC.1136

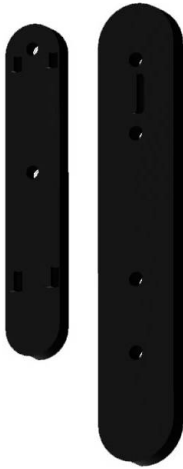

AC.1136

AC.1135

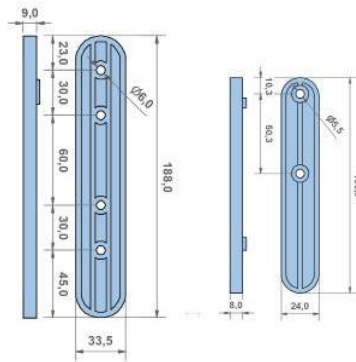

AC.1135

0,020

Suplemento plástico para DB.454

Plastic supplement for DB.454

AC.1136

0,045

Suplemento plástico para DB.455

Plastic supplement for DB.455

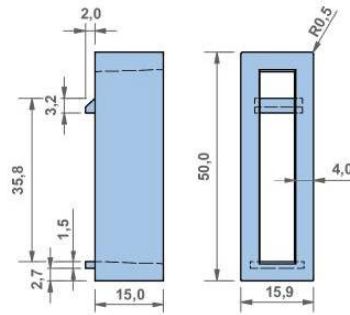

AC.1139

0,005

Suplemento plástico com 15mm para DB.412

Plastic supplement with 15mm for DB.412

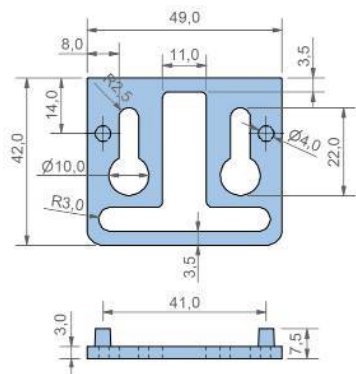

AC.1141

0,005

Suplemento plástico com 3mm para DB.415

Plastic supplement with 3mm for DB.415

AC.1143

 0,005

Suplemento plástico com 4mm para DB.513-516, DB.538, DB.540, DB.541, DB.555-560, DB.810 e DB.811

Plastic supplement with 4mm for DB.513-516, DB.538, DB.540, DB.541, DB.555-560, DB.810 and DB.811

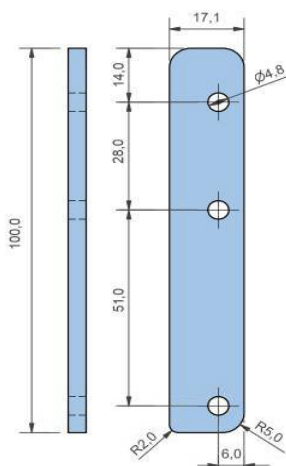

AC.1144

 0,010

Suplemento plástico com 10mm para DB.410 e DB.411

Plastic supplement with 10mm for DB.410 and DB.411

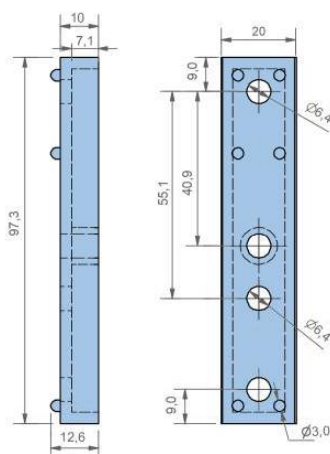

AC.1145

 0,015

Suplemento plástico com 5mm para DB.400 e DB.403

Plastic supplement with 5mm for DB. DB.400 and DB.403

AC.1146

 0,020

Suplemento plástico com 7mm para DB.400 e DB.403

Plastic supplement with 7mm for DB. DB.400 and DB.403

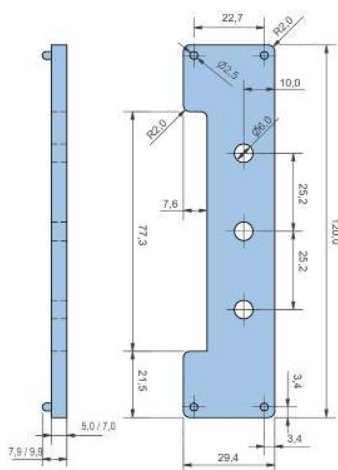

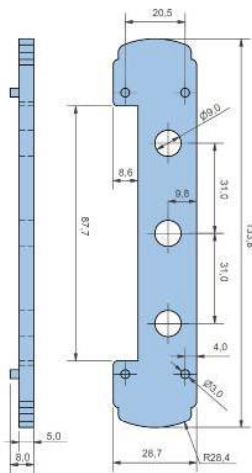

AC.1147

0,020

Suplemento plástico com 5mm para DB.404

Plastic supplement with 5mm for DB. DB.404

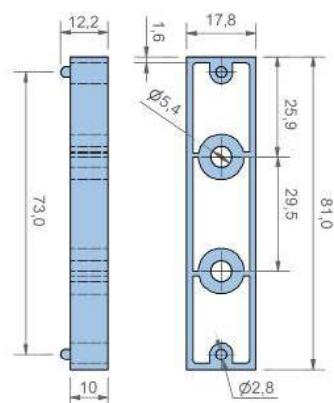

AC.1148

0,005

Suplemento plástico com 10mm para DB.420

Plastic supplement with 10mm for DB. DB.420

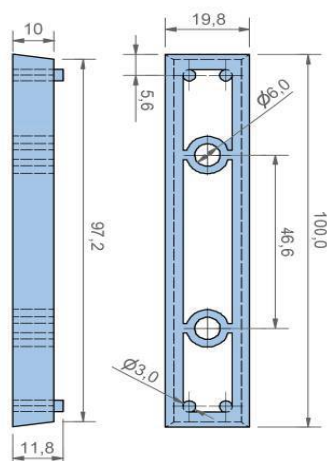

AC.1149

0,010

Suplemento plástico com 10mm para DB.445

Plastic supplement with 10mm for DB. DB.445

AC.1150

 0,010

Suplemento plástico preto para DB.468, DB.473, DB.474, DB.474 G, DB.474 G9, DB.475, DB.476, DB.830, DB.831, DV.2608 e DB.2640

Black plastic supplement for DB.468, DB.473, DB.474, DB.474 G, DB.474 G9, DB.475, DB.476, DB.830, DB.831, DV.2608 e DB.2640

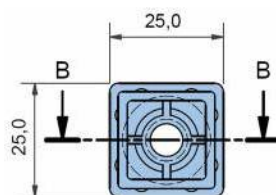

AC.1150 B

 0,010

Suplemento plástico branco para DB.468, DB.473, DB.474, DB.474 G, DB.474 G9, DB.475, DB.476, DB.830, DB.831, DV.2608 e DB.2640

White plastic supplement for DB.468, DB.473, DB.474, DB.474 G, DB.474 G9, DB.475, DB.476, DB.830, DB.831, DV.2608 e DB.2640

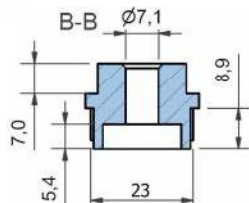

AC.801

 0,002

Suplemento plástico para dobradiça pivô série DB.820 e DB.821

Plastic pivot hinge supplement for DB.820 and DB.821 series

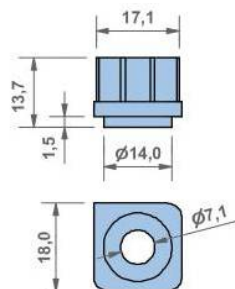

AC.1153

 0,001

Suplemento plástico para dobradiça de arca; DB.480-487

Plastic supplement for self balancing hinge DB.480-487

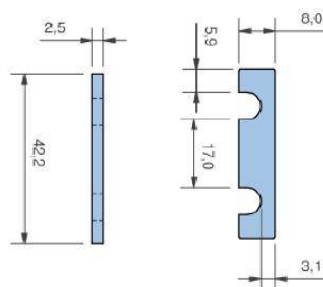

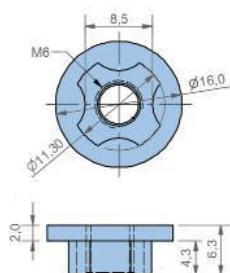
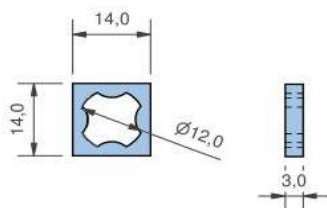
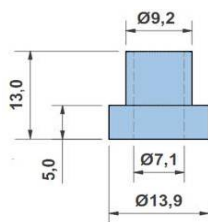
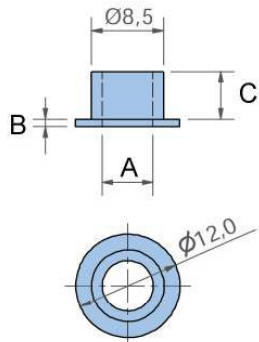

AC.1157

0,001

Casquilho plástico para veio com Ø6mm para DB.400-403

Plastic bushing for Ø6mm pin for DB.400-403

AC.1157-1

0,001

Casquilho plástico para veio com Ø7mm compatível com DB.513 e DB.514

Plastic bushing with Ø7mm pin compatible with DB.513 and DB.514

	ØA (MM)	B (MM)	C (MM)
AC.1157	6,0	0,9	5,6
AC.1157-1	6,9	0,8	7,6

DB0270002 (AC.1476)

0,001

Casquilho plástico para veio com Ø7mm para DB.412

Plastic bushing with Ø7mm pin for DB.412

AC.1164

0,002

Anilha em zamak com encaixe estrela para dobradiça pivô

Zamak star shape washer for pivot hinge

AC.1151

0,005

Porca de encaixe em zamak níquelado, rosca M6, espessura 6mm;

Nickel plated zamak engaging nut, M6 thread, 6mm thickness;

AC.1618

 0,020

Casquilho em plástico Ø18.0x11.5 (Ø7.0);

Plastic bushing Ø18.0x11.5 (Ø7.0);

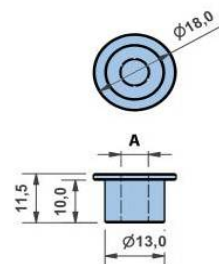

AC.1618-1

 0,020

Casquilho em plástico Ø18.0x11.5 (Ø6.0);

Plastic bushing Ø18.0x11.5 (Ø6.0);

AC.1240

 0,010

Suplemento plástico para dobradiça pivô séries DB.850 e DB.870;

Plastic pivot hinge supplement for DB.850 and DB.870 series;

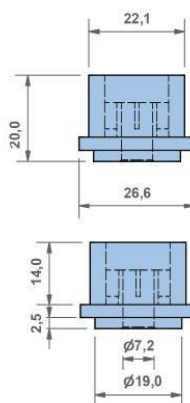

AC.1241

 0,010

Suplemento plástico para dobradiça pivô séries DB.850 e DB.870;

Plastic pivot hinge supplement for DB.850 and DB.870 series;

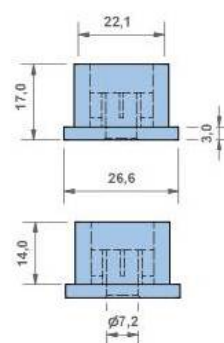

AC.1242

 0,010

Suplemento plástico para dobradiça pivô séries DB.850 e DB.870;

Plastic pivot hinge supplement for DB.850 and DB.870 series;

