

LES



04

PUXADORES

HANDLES

DOORES

112 PUXADORES PARA ARCAS FRIGORÍFICAS
HANDLES FOR CHEST FREEZERS

114 PUXADORES DE EMBUTIR
RECESSED PULLS

118 PUXADORES DE PORTA
DOOR HANDLES

120 ASAS
PULLS

129 PUXADORES DIVERSOS
HANDLES AND KNOBS

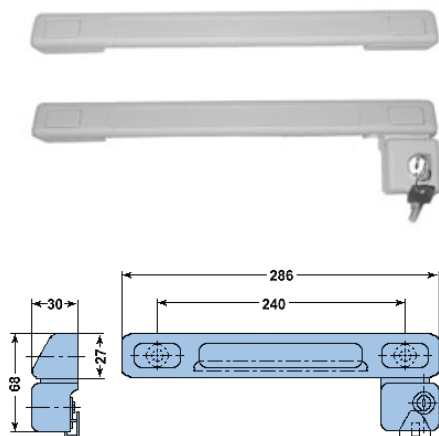

Outras cores sob consulta
Other colours upon request

PX.700 - PX.701-1

Puxador em poliamida (PA) para arcas frigoríficas

Polyamide (PA) handle for chest freezers

	CHAVE KEY	SEGURANÇA SECURITY	COR COLOUR
PX.700	-	-	BRANCO/WHITE
PX.700 C	-	-	CINZA/GREY
PX.701	X	-	BRANCO/WHITE
PX.701-1	X	X	BRANCO/WHITE

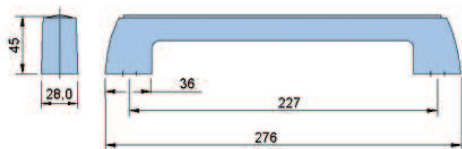

PX.702

Puxador em ABS com espelho anodizado natural para congeladores verticais

Cor: Preto

*ABS handle with anodised aluminium cover for vertical freezers
Colour: Black*

PX.702 C

Puxador em ABS com espelho anodizado castanho para congeladores verticais

Cor: Castanho

*ABS handle with brown anodised aluminium cover for vertical freezers
Colour: Brown*

PX.703 - PX.704-1

Puxador em ABS para arcas frigoríficas

ABS handle for chest freezers

	CHAVE KEY	SEGURANÇA SECURITY	COR COLOUR
PX.703	-	-	BRANCO/WHITE
PX.704	X	-	BRANCO/WHITE
PX.704-1	X	X	BRANCO/WHITE

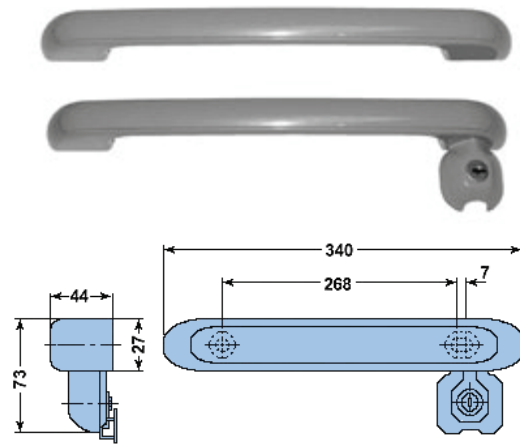

Outras cores sob consulta
Other colours upon request

Acessórios para PX.703 e PX.704
Disponíveis sob consulta

Accessories for handles PX.703 and PX.704
Available upon request

DESIGNAÇÃO DESIGNATION

AC.1152	TRINCO STRIKE
AC.1155	FECHADURA COM CHAVE LOCK WITH KEY
AC.1156	LINGUETE HOOK
AC.1162	ESPELHO COVER

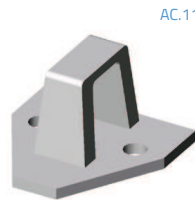

AC.1152



AC.1155



AC.1156



AC.1162

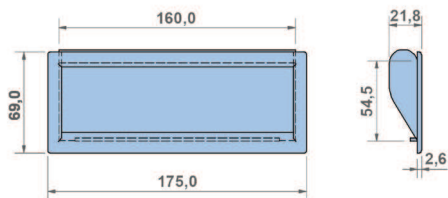

PX.711 - PX.711 C

Puxador de embutir em ABS com 175x69mm

ABS recessed handle with 175x69mm

PX.711 - Preto / *Black*

PX.711 C - Cinza / *Grey*

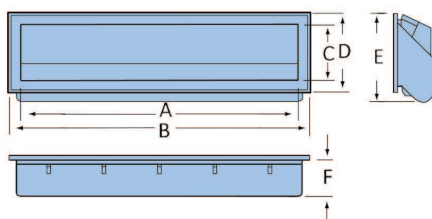

PX.714 - PX.716

Puxadores em ABS preto para embutir

Black ABS recessed handles

	A (mm)	B (mm)	C (mm)	D (mm)	E (mm)	F (mm)
PX.714	127	138	25	37	40	16
PX.715	178	189	33	44	52	22
PX.716	126	140	22	36	39	30

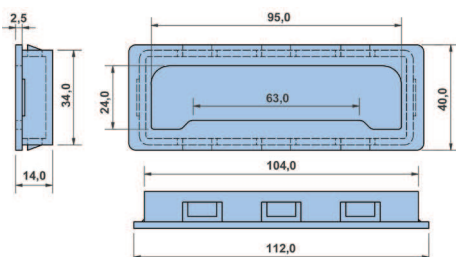

PX.781

Puxador de embutir em poliamida (PA) preto com 112x40mm

Black polyamide (PA) recessed handle with 112x40mm

PX.782

Puxador de embutir em poliamida (PA) preto com 97x38mm

Black polyamide (PA) recessed handle with 97x38mm

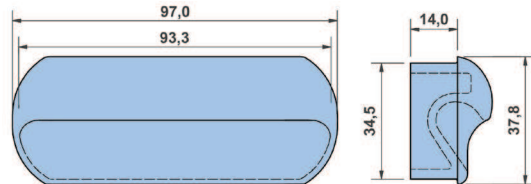

PX.718

Puxador unheiro de embutir em ABS, com 105x23,5mm

ABS recessed handle with 105x23,5mm

PX.718 - Branco / *White*

PX.718 P - Preto / *Black*

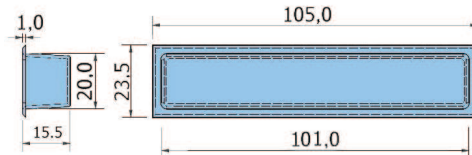

PX.719

Puxador unheiro de embutir em poliamida (PA) preto com 92x26mm

Black polyamide (PA) recessed handle with 92x26mm

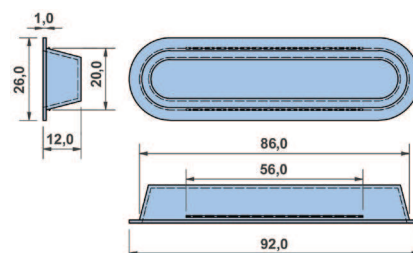

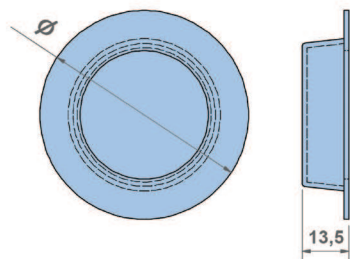

PX.821-822

Puxador de embutir em inox
Stainless steel recessed handle

	\varnothing (mm)
PX.821	50
PX.822	65

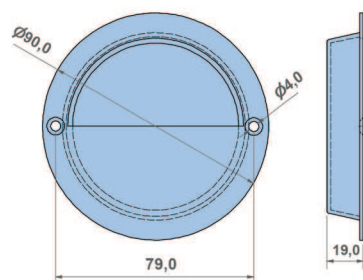

PX.823

Puxador de embutir em inox
Redondo $\varnothing 90\text{mm}$
Stainless steel recessed handle
Round $\varnothing 90\text{mm}$

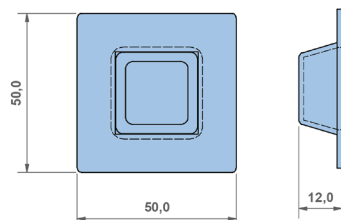
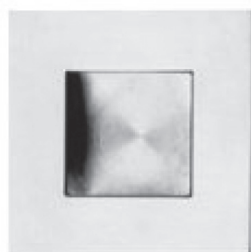

PX.824

Puxador de embutir em inox
Quadrado 50x50mm
Stainless steel recessed handle
Square 50x50mm

PX.825

Puxador de embutir em inox
Oval 120x40mm

*Stainless steel recessed handle
Oval 120x40mm*

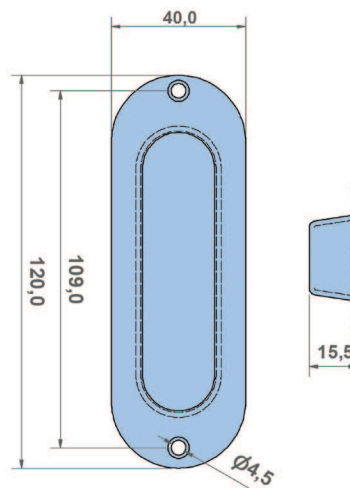

PX.826

Puxador de embutir em inox
Rectangular 102x51mm

*Stainless steel recessed handle
Rectangular 102x51mm*

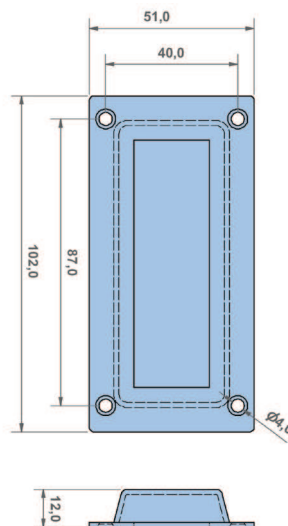

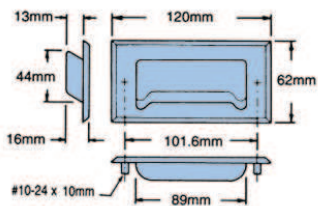
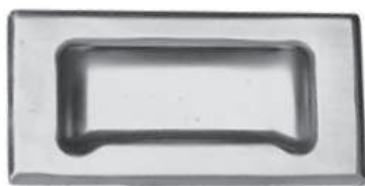

PX.950

Puxador de porta em inox biselado nos bordos
Inclui sistema de fixação

*Stainless steel door pull with beveled edge frame
Retaining locknuts provided*

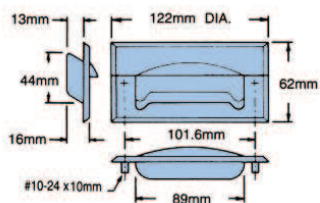
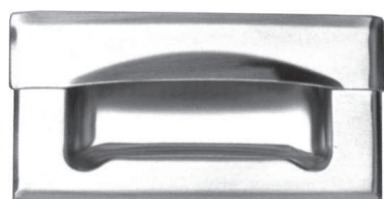

PX.951

Puxador de gaveta em inox biselado nos bordos
Inclui sistema de fixação

*Stainless steel drawer pull with beveled edge frame
Retaining locknuts provided*

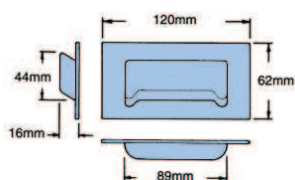
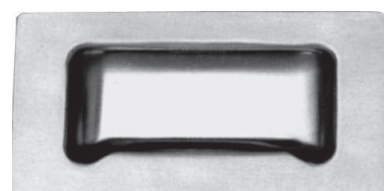

PX.952

Puxador plano de porta em inox para soldar

Flush type stainless steel door pull for welding

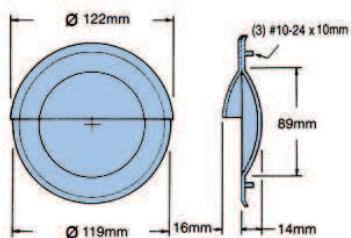
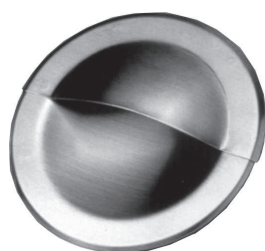

PX.953

Puxador redondo em inox biselado nos bordos
Inclui sistema de fixação

*Stainless steel round pull with beveled edge frame
Retaining locknuts provided*



PX.754

Perfil para puxador em alumínio anodizado natural

Natural anodised aluminum profile for handle

	COMPRIMENTO LENGTH
PX.754	5 MT
PX.754-3	3 MT
PX.754-6	6 MT

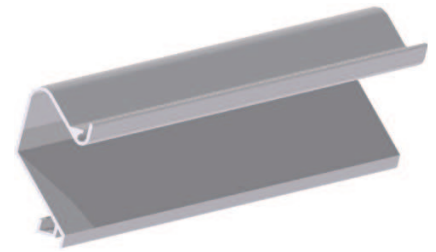
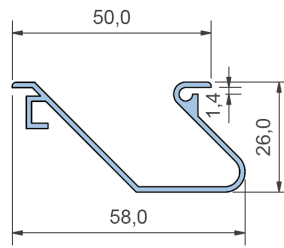

✓ Opção: Acabamento lacado sob consulta
Option: Lacquered finish upon request

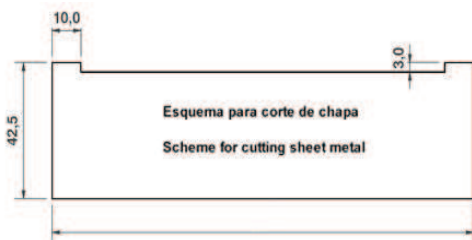

EXEMPLO DE APLICAÇÃO
EXAMPLE OF APPLICATION



PX.756 - PX.758

Par de terminais rectos para puxador PX.754

Straight top ends for handle PX.754 (pair)

PX.756 - Preto / Black

PX.758 - Cinza / Grey

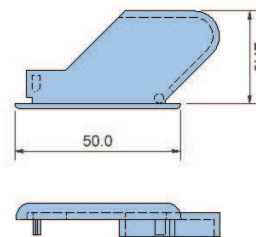

PX.760 - PX.760 C

Par de terminais curvos, para puxador PX.754

Curved top ends for handle PX.754 (pair)

PX.760 - Preto / Black

PX.760 C - Cinza / Grey

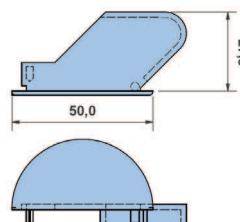

EXEMPLO DE APLICAÇÃO
EXAMPLE OF APPLICATION

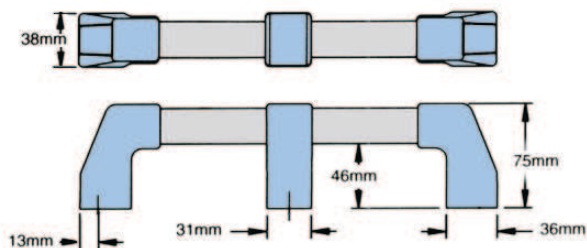
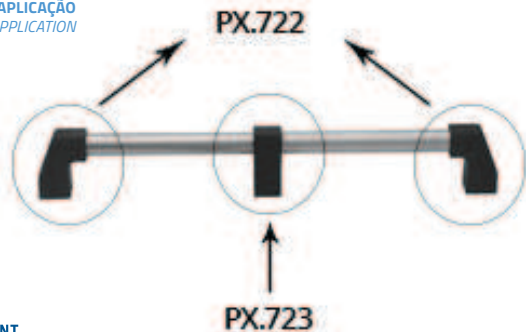

PX.722

Par de suportes laterais em poliamida (PA) com fibra de vidro para tubo Ø25mm
(Tubo não incluído)
Cor: Preto

*Polyamide (PA) reinforced with fiber glass end (pair) brackets for Ø25mm tube
(Tube not included)
Colour: Black*

PX.723

Suporte central em poliamida (PA) com fibra de vidro para tubo Ø25mm
(Tubo não incluído)
Cor: Preto

*Polyamide (PA) reinforced with fiber glass center support brackets for Ø25mm tube
(Tube not included)
Colour: Black*

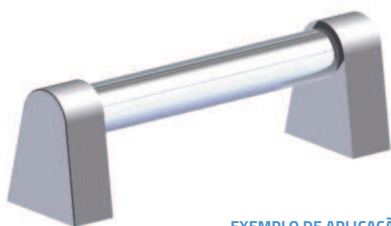
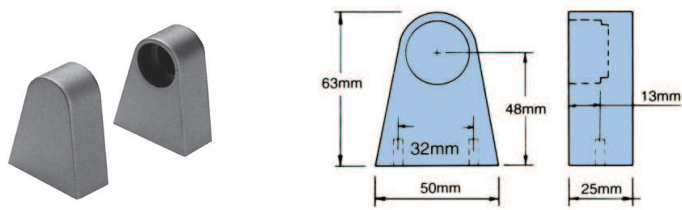

EXEMPLO DE APLICAÇÃO
EXAMPLE OF APPLICATION

PX.724

Par de suportes em alumínio, para tubo Ø25mm
(Tubo não incluído)

*Aluminium handle supports for Ø25mm tube
(Tube not included)*

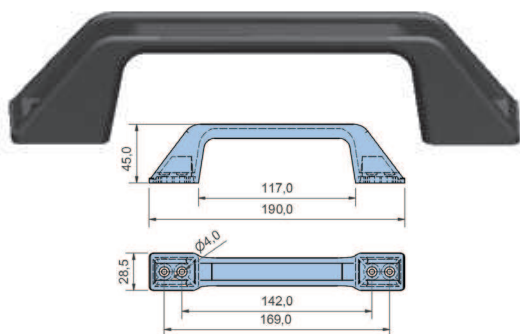

PX.705 - PX.705 B

Puxador em poliamida (PA) com 190x45mm para congeladores verticais

Polyamide (PA) handle with 190x45mm for vertical freezers

PX.705 - Preto / Black
PX.705 B - Branco / White



PX.706

Puxador em poliamida (PA) preta com 138x56mm para porta frigorífica

Black polyamide (PA) handle with 138x56mm for refrigerator door

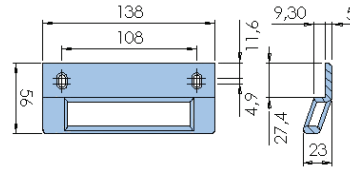

PX.713

Puxador em ABS branco para porta frigorífica, com 162mm

White ABS handle for refrigerator door with 162mm

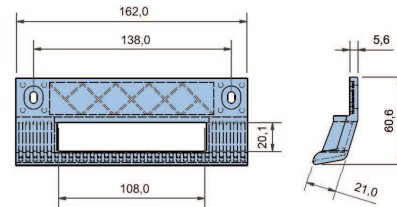
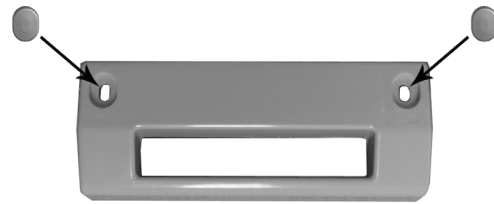

 Outras cores sob consulta
Other colours upon request

PX.710 - PX.710 C

Puxador em poliamida (PA) com 112x19mm

Polyamide (PA) handle with 112x19mm

- PX.710** - Preto / Black
- PX.710 B** - Branco / White
- PX.710 C** - Cinza / Grey

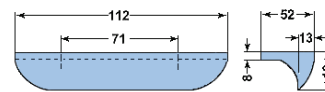

PX.730

Puxador em zamak 5 cromado brilhante com 110x19mm

Bright chrome plated zamak 5 handle with 110x19mm

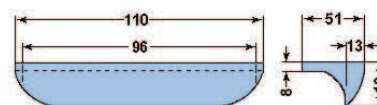

COMPONENT
HARDWARE

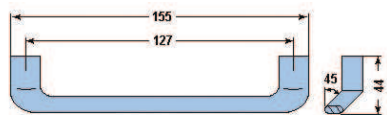

PX.731

Asa em zamak 5 cromado brilhante com 155mm

Bright chrome plated zamak 5 pull with 155mm

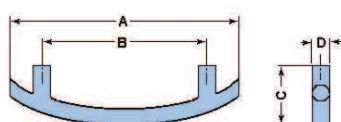

PX.732-733

Asa em zamak 5 cromado brilhante

Bright chrome plated zamak 5 pull

	A (mm)	B (mm)	C (mm)	D (mm)
PX.732	129	96	32	10
PX.733	165	128	35	11

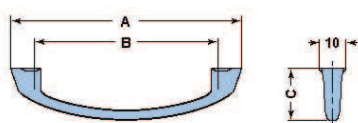

PX.734-736

Asa em zamak 5 cromado brilhante

Bright chrome plated zamak 5 pull

	A (mm)	B (mm)	C (mm)
PX.734	85	60	22
PX.735	105	80	24
PX.736	128	100	26

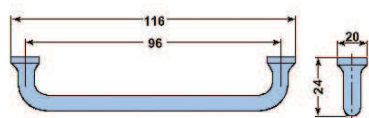

PX.737

Asa em zamak 5 cromado brilhante com 116x24mm
Rosca M4

*Bright chrome plated zamak 5 pull with 116x24mm
M4 thread*



PX.742-745

Asa em zamak 5 cromado mate
Fornecida com parafusos

Matte chrome plated zamak 5 pull
Supplied with screws

	A (mm)	B (mm)	C (mm)	D (mm)
PX.742	92	64	20	9
PX.743	125	96	25	10
PX.744	166	128	30	11
PX.745	202	160	31	12

✓ Disponível em Niquelado Escovado
Available in brushed nickel plated

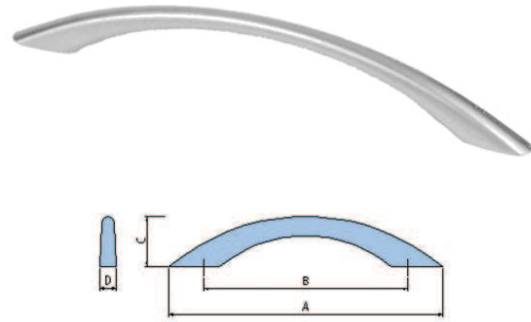

PX.746

Asa em zamak 5 cromado mate com 164x28mm
Fornecida com parafusos

Matte chrome plated zamak 5 pull with 164x28mm
Supplied with screws

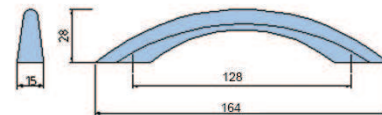

PX.747

Asa em zamak 5 cromado mate com 155x27mm
Fornecida com parafusos

Matte chrome plated zamak 5 pull with 155x27mm
Supplied with screws

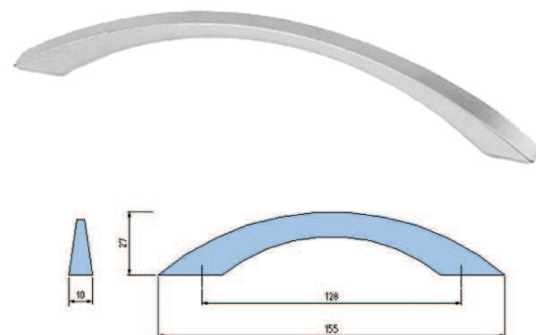

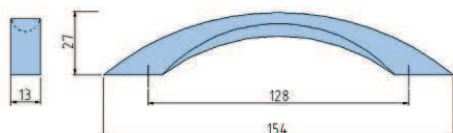

PX.748

Asa em zamak 5 com 154x27mm
Fornecida com parafusos

*Zamak 5 pull with 154x27mm
Supplied with screws*

ACABAMENTO FINISH

PX.748

CROMADO MATE
BRIGHT CHROME

PX.748-1

NIQUELADO ESCOVADO
BRUSHED NICKEL PLATED

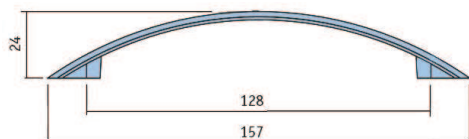

PX.749

Asa em zamak 5 cromado mate com 157x24mm
Fornecida com parafusos

*Matte chrome plated zamak 5 pull with 157x24mm
Supplied with screws*

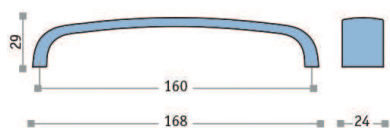

PX.762

Asa em zamak 5 niquelado escovado 168x29mm

Brushed nickel plated zamak 5 pull 168x29mm



PX.764 - 767

Asa em zamak 5

Zamak 5 pull

	A (mm)	B (mm)	C (mm)	D (mm)	ACABAMENTO FINISH
PX.764	94	64	17	8	CROMADO BRILHANTE BRIGHT CHROME PLATED
PX.765	132	96	20	9	
PX.766	168	128	24	10	
PX.767	198	160	27	10	
PX.764 NI	94	64	17	8	NIQUELADO MATE MATTE NICKEL PLATED
PX.765 NI	132	96	20	9	
PX.766 NI	168	128	24	10	
PX.767 NI	198	160	27	10	

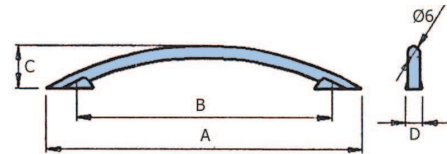

PX.768

Asa em zamak 5 com 143x28mm

Zamak 5 pull with 143x28mm

	ACABAMENTO FINISH
PX.768	CROMADO MATE BRIGHT CHROME
PX.768-1	NIQUELADO ESCOVADO BRUSHED NICKEL PLATED

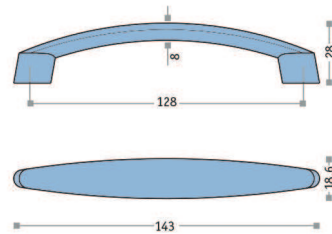

PX.769

Asa em zamak 5 niquelado escovado com 178x26mm

Brushed nickel plated zamak 5 pull with 178x26mm

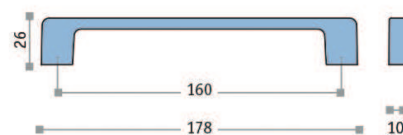

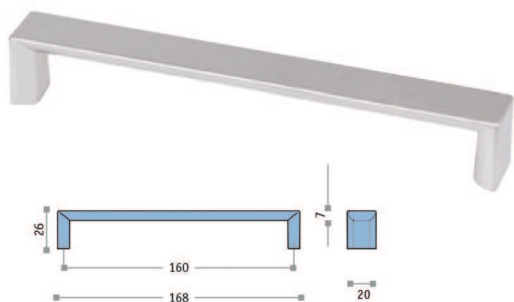

PX.770

Asa em zamak 5 niquelado escovado 168x26mm
Brushed nickel plated zamak 5 pull 168x26mm

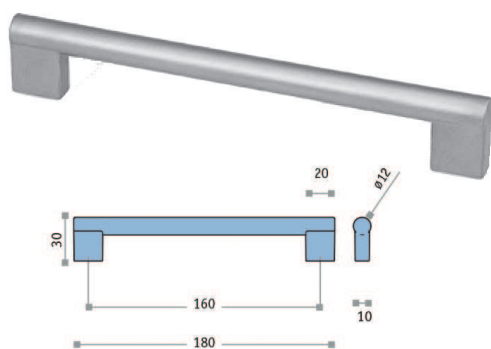

PX.771

Asa em zamak 5 niquelado escovado 180x30mm
Brushed nickel plated zamak 5 pull 180x30mm

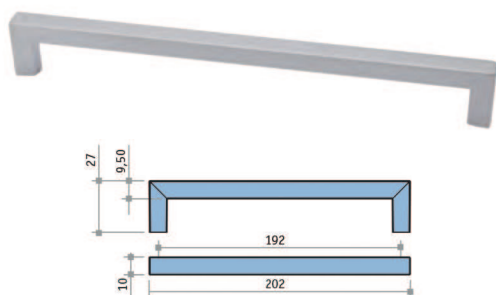

PX.772

Asa em zamak 5 niquelado escovado 202x27mm
Brushed nickel plated zamak 5 pull 202x27mm

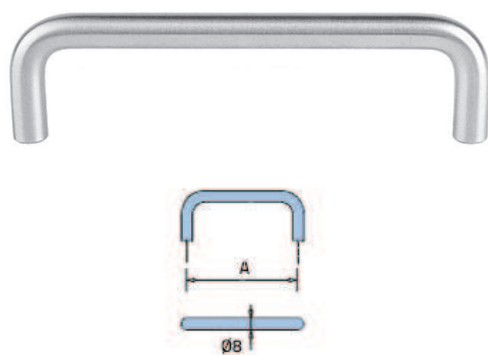

PX.1604 - 1607

Asa recta em inox
 Fornecida com parafusos M4x25mm
*Stainless steel straight pull
 Supplied with M4x25mm screws*

	A (mm)
PX.1604	96
PX.1605	128
PX.1606	160
PX.1607	192

PX.1624 - 1631

Asa recta em inox
Fornecida com parafusos M4x25mm

Stainless steel straight pull
Supplied with M4x25mm screws

	A (mm)
PX.1624	64
PX.1625	96
PX.1626	128
PX.1627	160
PX.1628	192
PX.1629	224
PX.1630	320
PX.1631	415

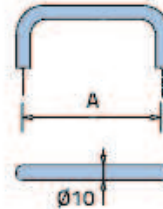

PX.1608 - 1611

Asa curva em inox
Fornecida com parafusos M4x25mm

Stainless steel curved pull
Supplied with M4x25mm screws

	A (mm)
PX.1608	96
PX.1609	128
PX.1610	160
PX.1611	192

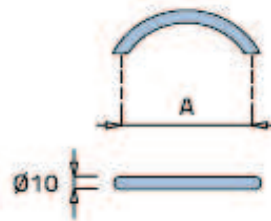

PX.1634

Asa Assimétrica Inox 128x35mm

Asymmetric Stainless Steel Handle 128x35mm

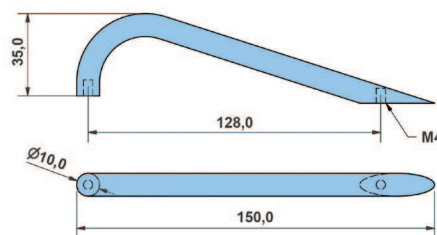

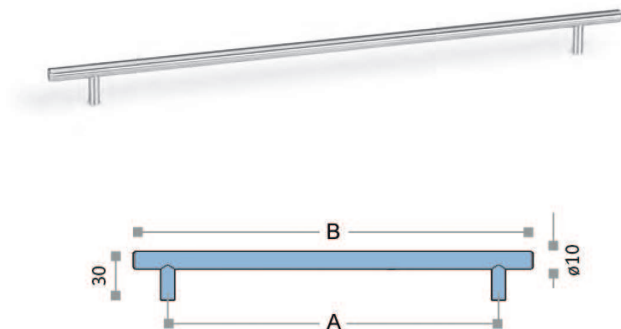

PX.1659 - 1663

Asa em inox
Fornecida com parafusos M4x25mm

*Stainless steel pull
Supplied with M4x25mm screws*

	A (mm)	B (mm)
PX.1659	96	160
PX.1660	128	192
PX.1661	192	258
PX.1662	256	320
PX.1663	544	608



MBX70

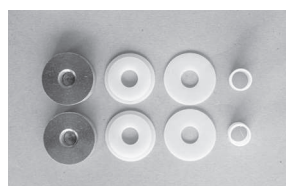

✓ **Opção:** Kit de fixação para asa simples
Option: Fixing kit for single pull application

PX.2903 - PX.2910

Asa em inox Ø25mm com parafusos de fixação M8

Stainless steel Ø25mm pull with M8 fixing screws

	A (mm)
PX.2903	300
PX.2904	350
PX.2905	400
PX.2906	500
PX.2907	1000
PX.2908	570
PX.2909	670
PX.2910	740

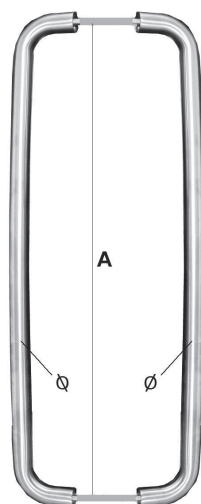

✓ **Opção:** Kit de fixação para asa dupla
Option: Fixing kit for double pull application

PX.2903-1 A PX.2910-1

Par asas em inox Ø25mm com parafusos de fixação M8

Stainless steel Ø25mm double pull with M8 fixing screws

	A (mm)
PX.2903-1	300
PX.2904-1	350
PX.2905-1	400
PX.2906-1	500
PX.2907-1	1000
PX.2908-1	570
PX.2909-1	670
PX.2910-1	740

PX.830-831

Puxador esfera em baquelite com rosca

Bakelite ball knobs with plastic thread

	A (mm)	ROSCA THREAD	Ø (D)
PX.830	20	M6	25
PX.831	15	M5	20

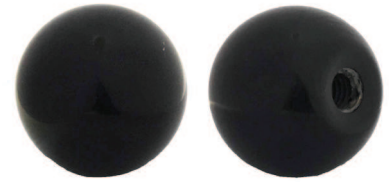
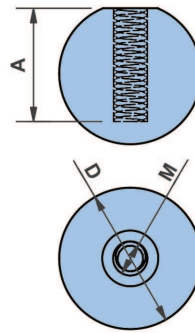

PX.838-839-3

Manípulos de 4 orelhas

Star knobs

	A (mm)	ROSCA THREAD
PX.838	16	M6
PX.839	15	M8
PX.839-3	30	M8

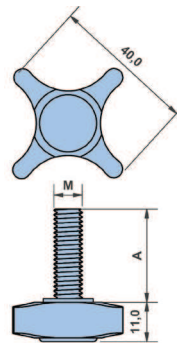

PX.850-851

Puxador em zamak níquelado
Fornecido com parafuso M4x25mm

*Nickel plated zamak knob
Supplied with M4x25mm screw*

	A (mm)	Ø (mm)
PX.850	21	25
PX.851	23	30

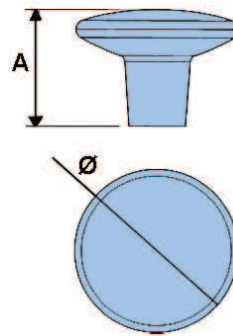

PX.1618-1620

Puxador simples em inox para fixação central
Fornecido com parafuso M4x25mm

*Stainless steel knob
Supplied with M4x25mm screw*

	A (mm)	Ø (mm)
PX.1618	26	15
PX.1619	28	20
PX.1620	30	25

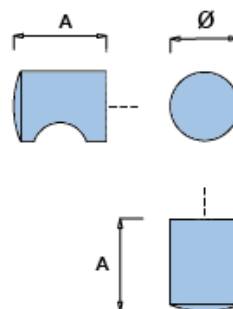

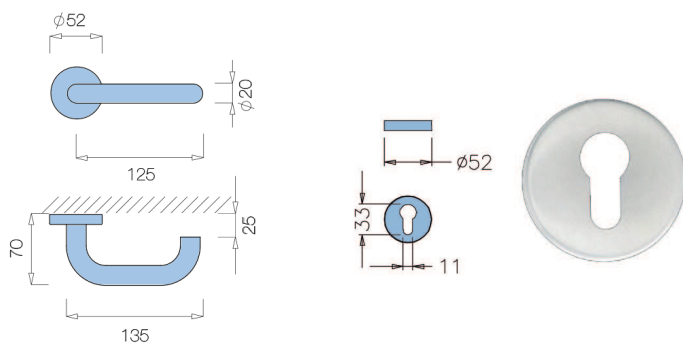

PX.2000-16

Puxador (par) de porta em Inox
Inclui espelho para cilindro tipo europeu
Quadra de 8mm

*Stainless steel door handle (pair)
Includes escutcheon for european cylinder
8mm square spindle*

130

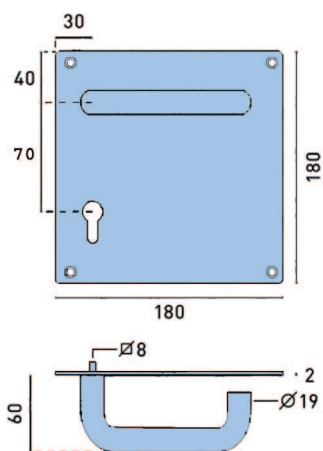

PX.2201

Puxador par em inox c/ espelho quadrado sem entrada
para cilindro
Quadra de 8mm

*Stainless steel door handle on square plate (pair) without
entrance for cylinder
8mm square spindle*

PX.2202

Puxador par em inox c/ espelho quadrado
e entrada para cilindro tipo europeu
Quadra de 8mm

*Stainless steel door handle on square plate (pair)
with entrance for European cylinder
8mm square spindle*

AC.1480

Puxador em aço inox com 102x70mm

Stainless steel handle with 102x70mm

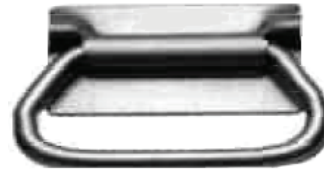

COMPONENT
HARDWARE

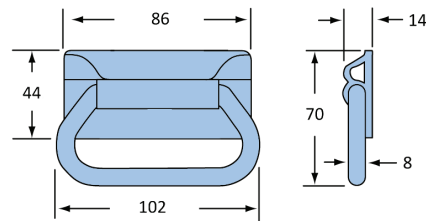

AC.1481

Puxador em aço inox com 90x57mm

Stainless steel handle with 90x57mm



COMPONENT
HARDWARE

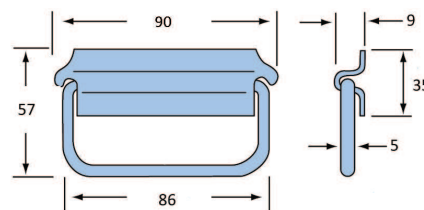



mm



Kg



mm

Não é permitida a reprodução integral ou parcial do catálogo sem autorização expressa da Fajota, S.A.
A Fajota, S.A. reserva-se o direito de efectuar alterações aos produtos sem informação prévia.
As dimensões e pesos apresentados são meramente indicativos podendo variar ligeiramente.

*Complete or partial reproduction of this catalogue is not allowed without the express permission of Fajota, S.A.
Fajota, S.A. reserves the right to make changes to products without prior notice.
The dimensions and weights presented are merely indicative and may suffer variations.*

CONTACTE-NOS PARA MAIS INFORMAÇÕES OU VISITE O NOSSO SITE
CONTACT US FOR MORE INFORMATION OR VISIT OUR WEBSITE

FAJOTA.PT